

511981 FAG

Tapered roller bearings

TYPE: Roller bearings, Tapered, Double row, O-arrangement, metric size, design 2 (FAG)

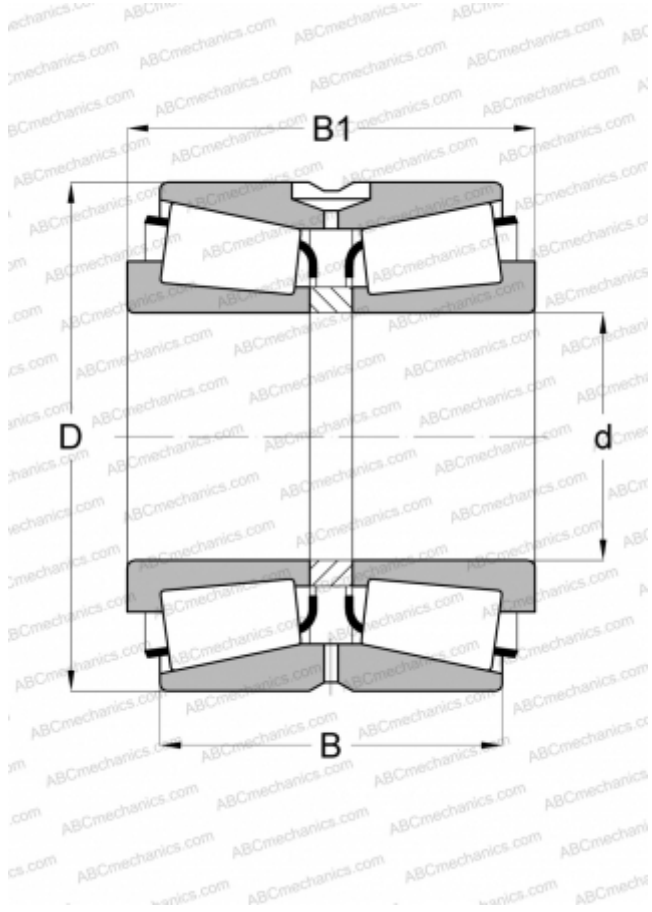

Technical specification

DIMENSIONS, MM

d	200,000
D	310,000
B	152,000
C	123,000

WEIGHT, KG

40,100

MANUFACTURER

[FAG](#)