

511983 FAG

Tapered roller bearings

TYPE: Roller bearings, Tapered, Double row, O-arrangement, metric size, design 2 (FAG)

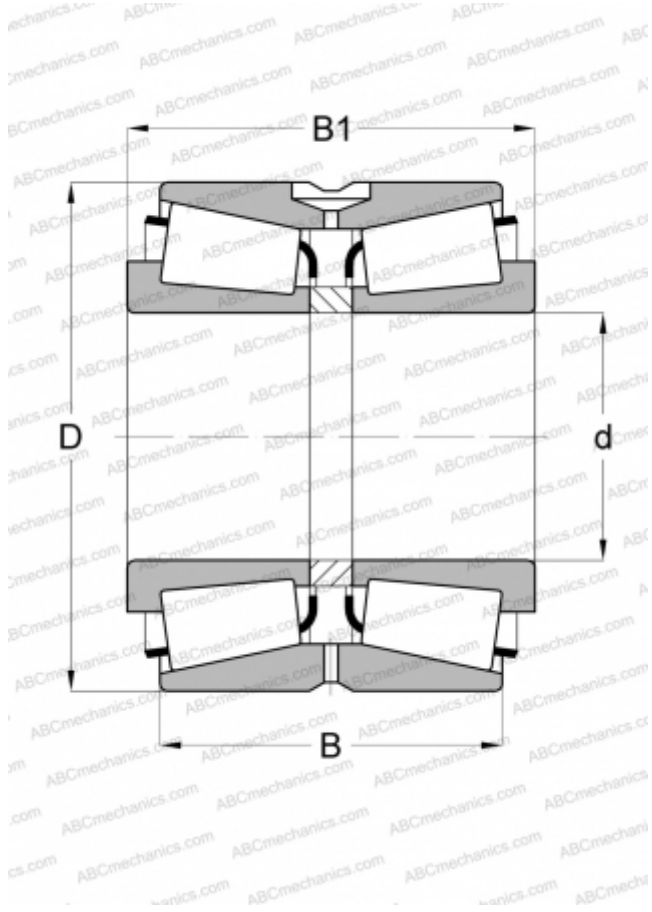

Technical specification

DIMENSIONS, MM

d	220,000
D	300,000
B	109,000
C	88,000

WEIGHT, KG

21,200

MANUFACTURER

[FAG](#)