

541910 FAG

Tapered roller bearings

TYPE: Roller bearings, Tapered, Double row, O-arrangement, metric size, design 2 (FAG)

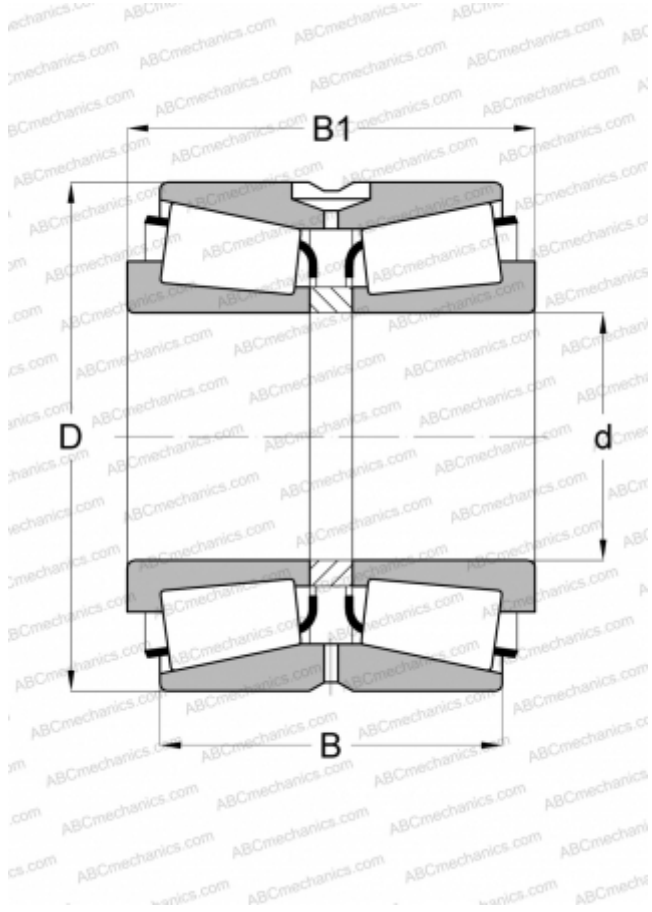

Technical specification

DIMENSIONS, MM

d	230,000
D	355,000
B	145,000
C	110,000

WEIGHT, KG

48,700

MANUFACTURER

[FAG](#)