

539117 FAG

Tapered roller bearings

TYPE: Roller bearings, Tapered, Double row, O-arrangement, metric size, design 2 (FAG)

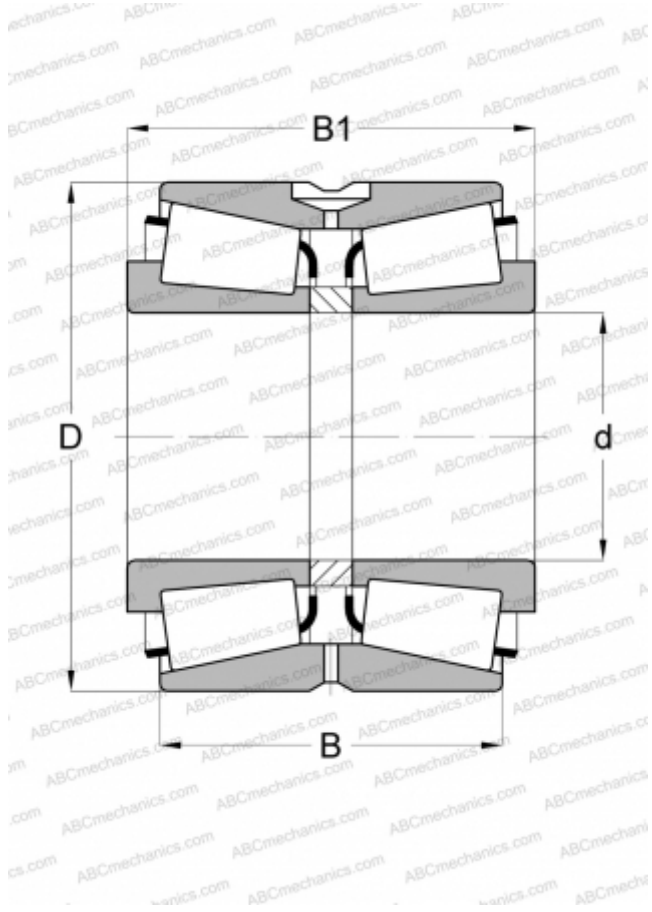

Technical specification

DIMENSIONS, MM

d	520,000
D	740,000
B	190,000
C	120,000

WEIGHT, KG

225,000

MANUFACTURER

[FAG](#)