

510043 FAG

Tapered roller bearings

TYPE: Roller bearings, Tapered, Double row, O-arrangement, metric size, design 2 (FAG)

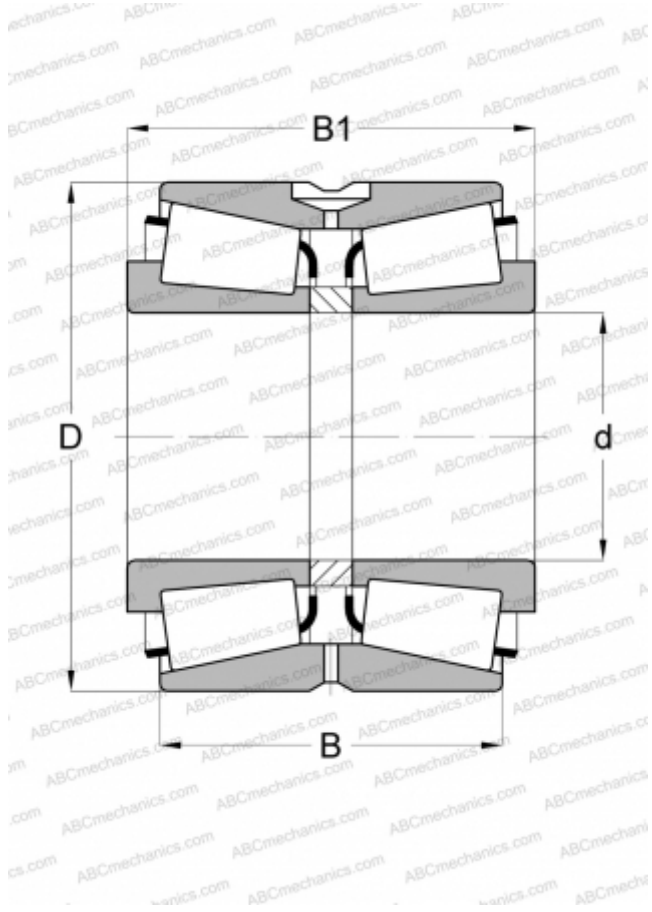

Technical specification

DIMENSIONS, MM

d	530,000
D	710,000
B	190,000
C	136,000

WEIGHT, KG

194,000

MANUFACTURER

[FAG](#)