

578732 FAG

Tapered roller bearings

TYPE: Roller bearings, Tapered, Double row, O-arrangement, metric size, design 2 (FAG)

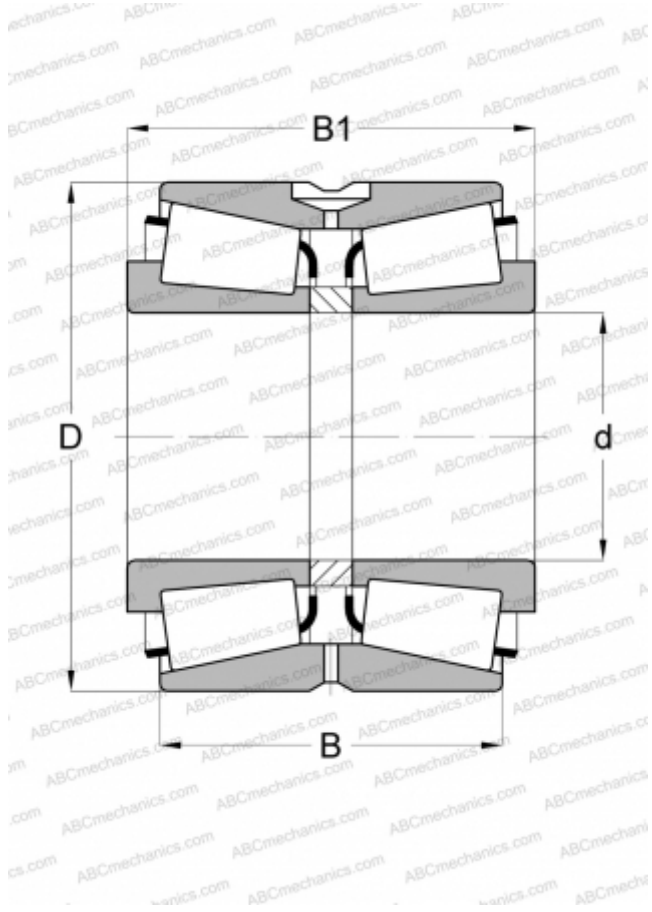

Technical specification

DIMENSIONS, MM

d	560,000
D	820,000
B	260,000
C	185,000

WEIGHT, KG

418,000

MANUFACTURER

[FAG](#)