

LM11749/LM11710 + K106398R/K106397R

TIMKEN

Tapered roller bearings

TYPE: Roller bearings, Tapered, Tapered roller bearing assembly, Type 2S, two single-row assemblies with snap ring spacer

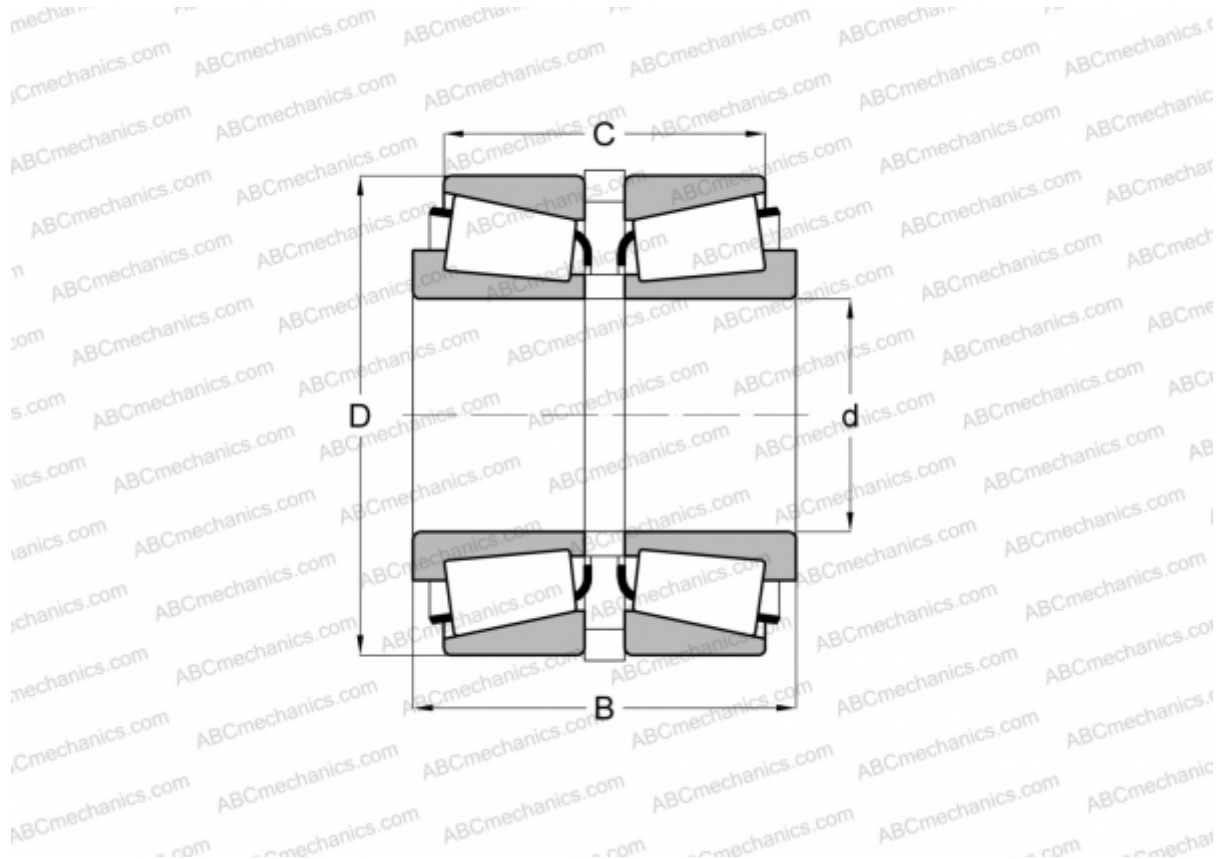

Technical specification

DIMENSIONS, MM

d	17,462
D	39,878
B	30,226
C	23,876

WEIGHT, KG 0,190

MANUFACTURER [TIMKEN](#)