

LM11949/LM11910 + K107061R/K107087R

TIMKEN

Tapered roller bearings

TYPE: Roller bearings, Tapered, Tapered roller bearing assembly, Type 2S, two single-row assemblies with snap ring spacer

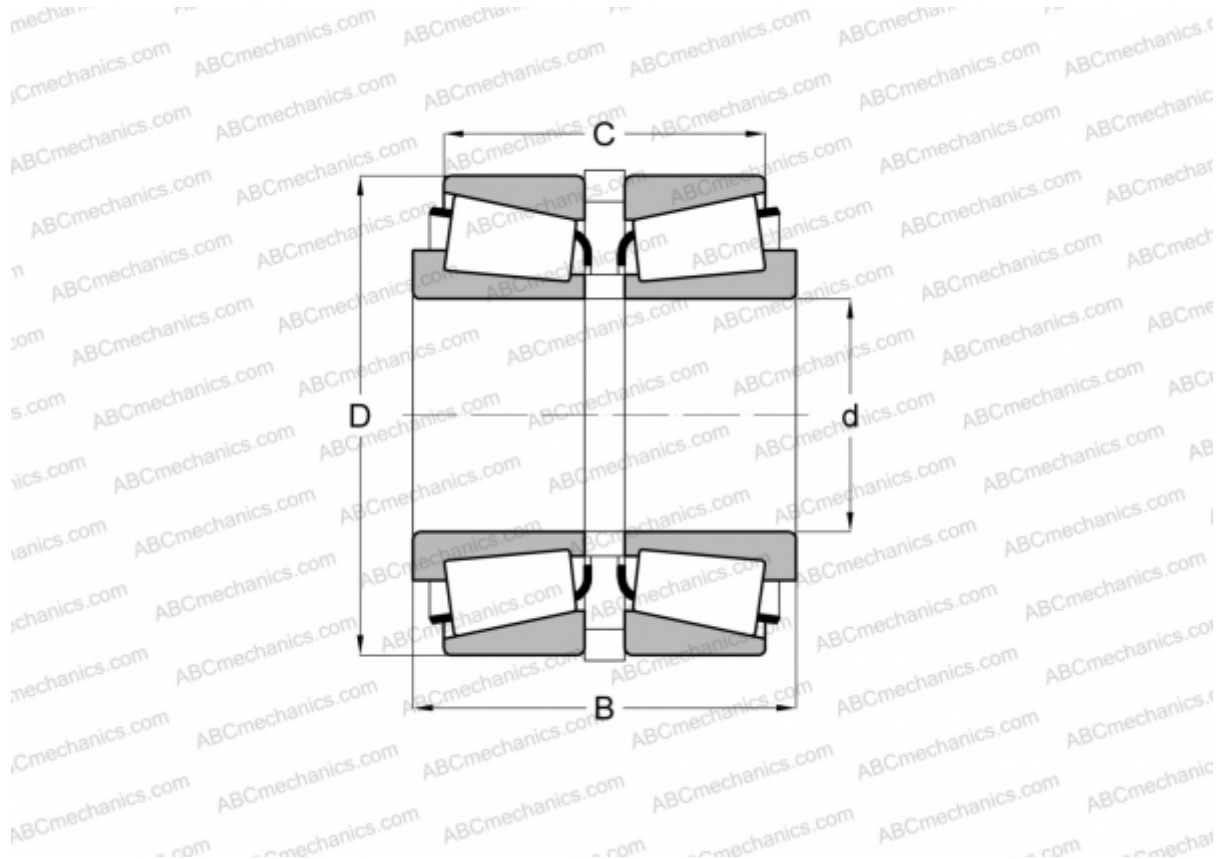

Technical specification

DIMENSIONS, MM

d	19,050
D	45,237
B	38,100
C	31,242

WEIGHT, KG 0,280

MANUFACTURER [TIMKEN](#)