

15578/15520 + X1S-15578/K158879R

TIMKEN

Tapered roller bearings

TYPE: Roller bearings, Tapered, Tapered roller bearing assembly, Type 2S, two single-row assemblies with snap ring spacer

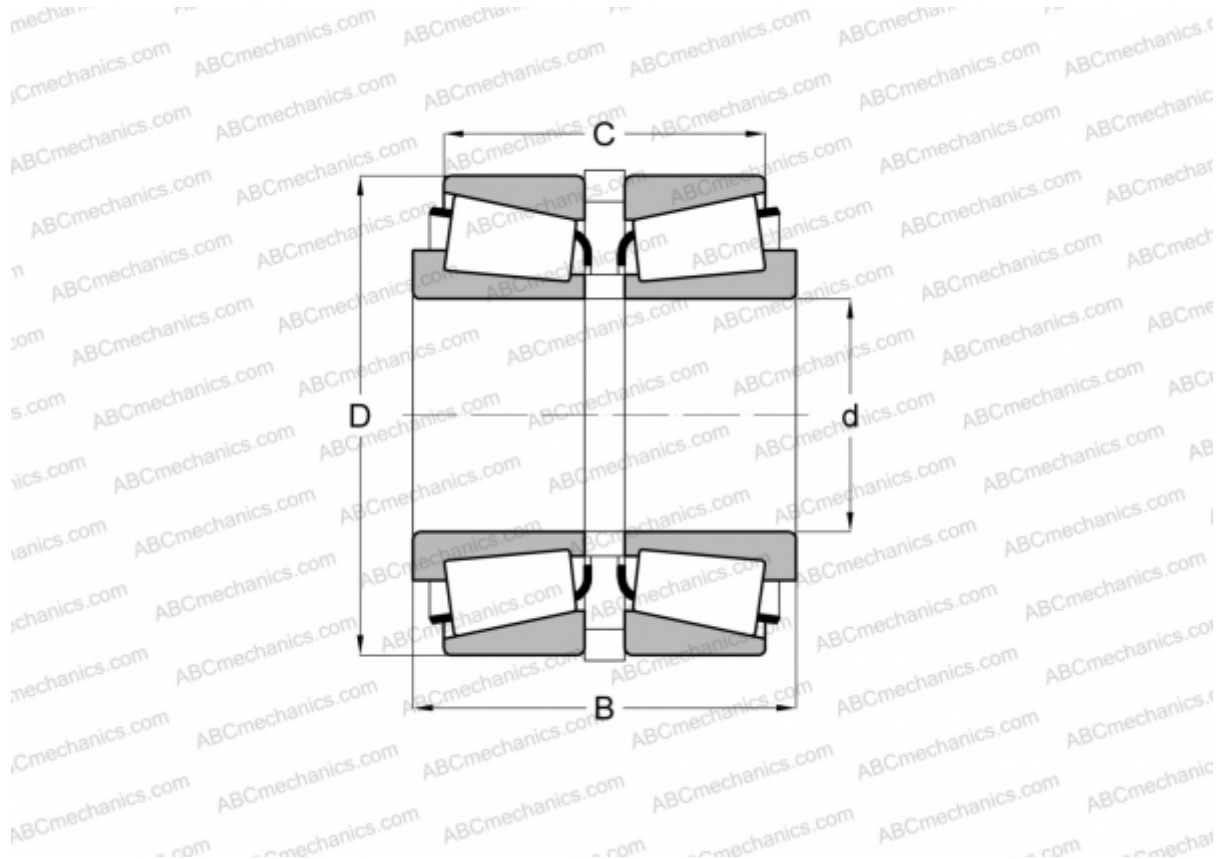

Technical specification

DIMENSIONS, MM

d	25,400
D	57,150
B	39,243
C	31,308

WEIGHT, KG 0,470

MANUFACTURER [TIMKEN](#)