

LM67048/LM67010 + K106817R/K106610R

TIMKEN

Tapered roller bearings

TYPE: Roller bearings, Tapered, Tapered roller bearing assembly, Type 2S, two single-row assemblies with snap ring spacer

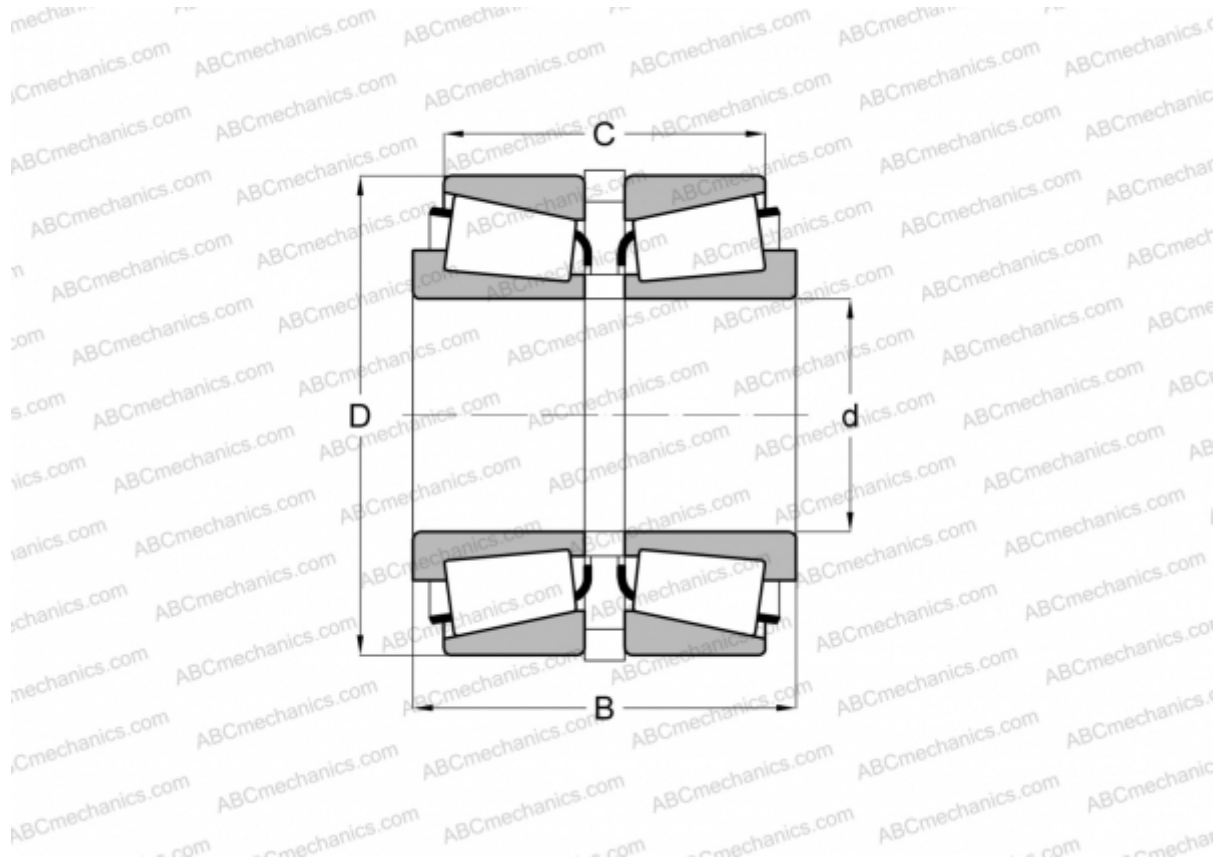

Technical specification

DIMENSIONS, MM

d	31,750
D	59,131
B	35,712
C	27,584

WEIGHT, KG 0,390

MANUFACTURER [TIMKEN](#)