

15125/15245 + X1S-15125/K159808R

TIMKEN

Tapered roller bearings

TYPE: Roller bearings, Tapered, Tapered roller bearing assembly, Type 2S, two single-row assemblies with snap ring spacer

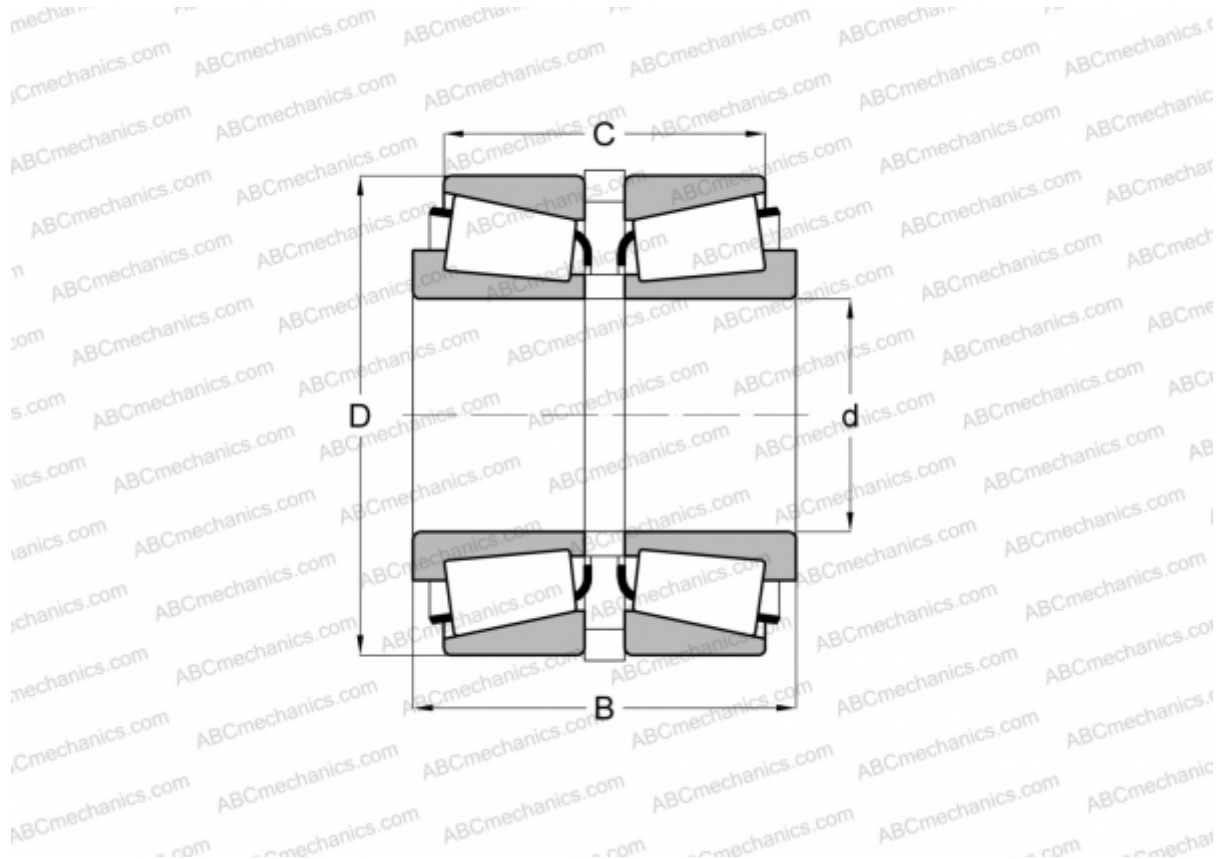

Technical specification

DIMENSIONS, MM

d	31,750
D	62,000
B	46,355
C	36,830

WEIGHT, KG 0,560

MANUFACTURER [TIMKEN](#)