

LM48548/LM48510 + K106389R/K106390R

TIMKEN

Tapered roller bearings

TYPE: Roller bearings, Tapered, Tapered roller bearing assembly, Type 2S, two single-row assemblies with snap ring spacer

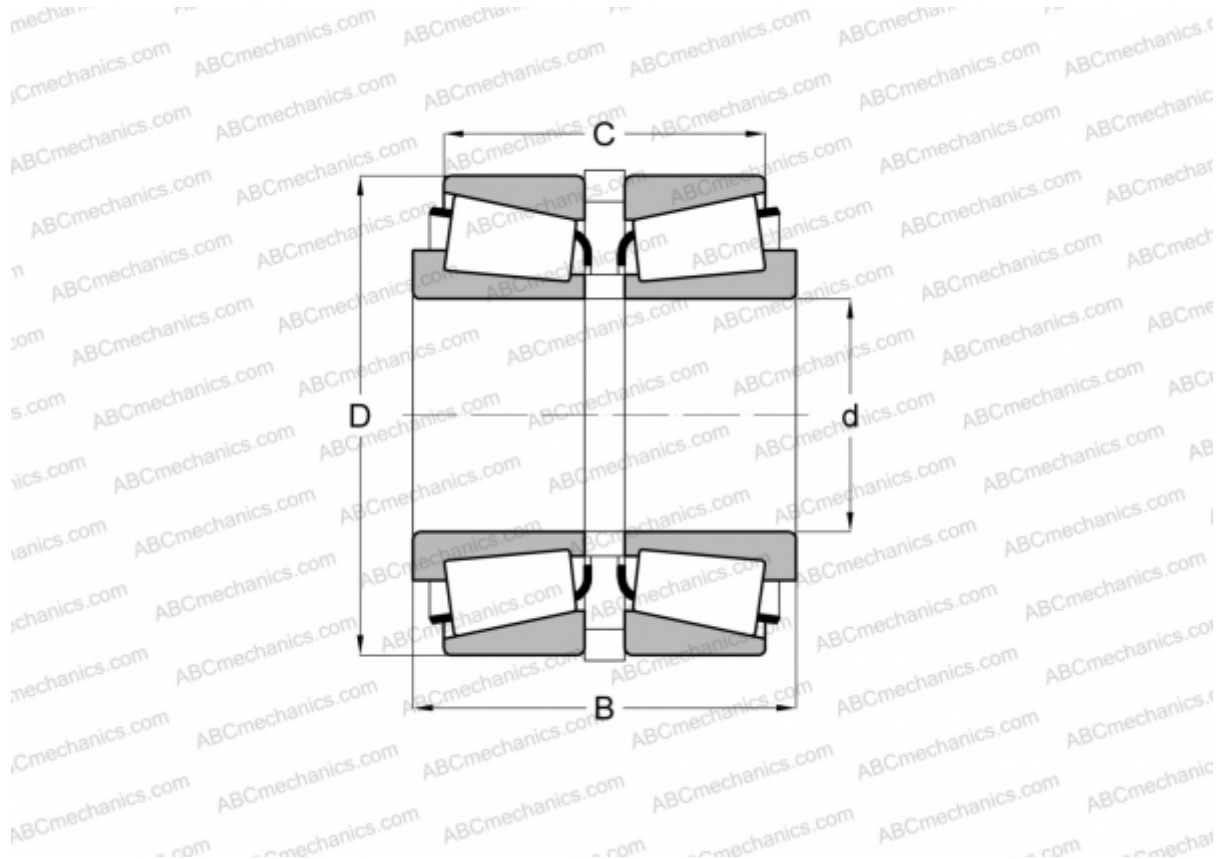

Technical specification

DIMENSIONS, MM

d	34,925
D	65,088
B	39,624
C	31,496

WEIGHT, KG 0,530

MANUFACTURER [TIMKEN](#)