

23691/23621 + K143257R/K109519R TIMKEN

Tapered roller bearings

TYPE: Roller bearings, Tapered, Tapered roller bearing assembly, Type 2S, two single-row assemblies with snap ring spacer

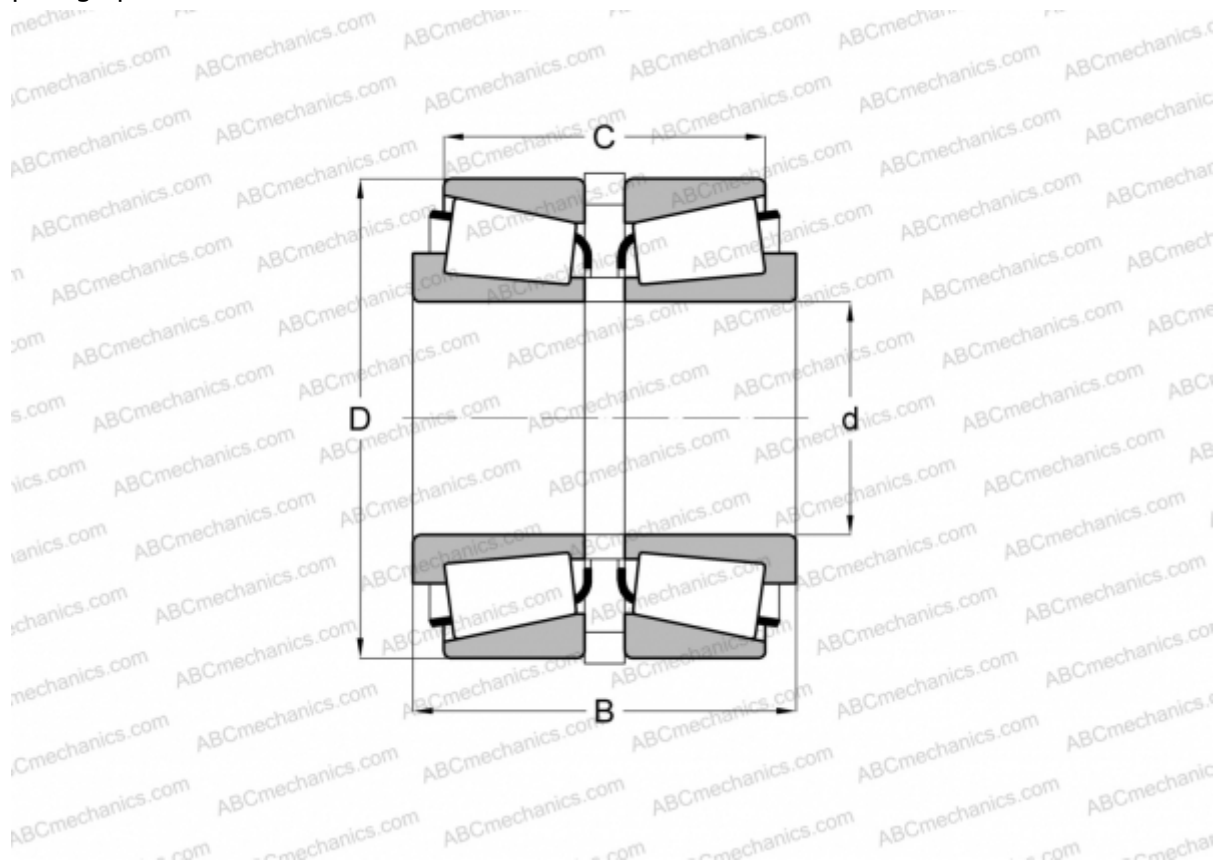

Technical specification

DIMENSIONS, MM

d	35,000
D	73,025
B	56,337
C	46,812

WEIGHT, KG 1,060

MANUFACTURER [TIMKEN](#)