

## LM29748/LM29710 + K106393R/K106390R

### TIMKEN

Tapered roller bearings

TYPE: Roller bearings, Tapered, Tapered roller bearing assembly, Type 2S, two single-row assemblies with snap ring spacer

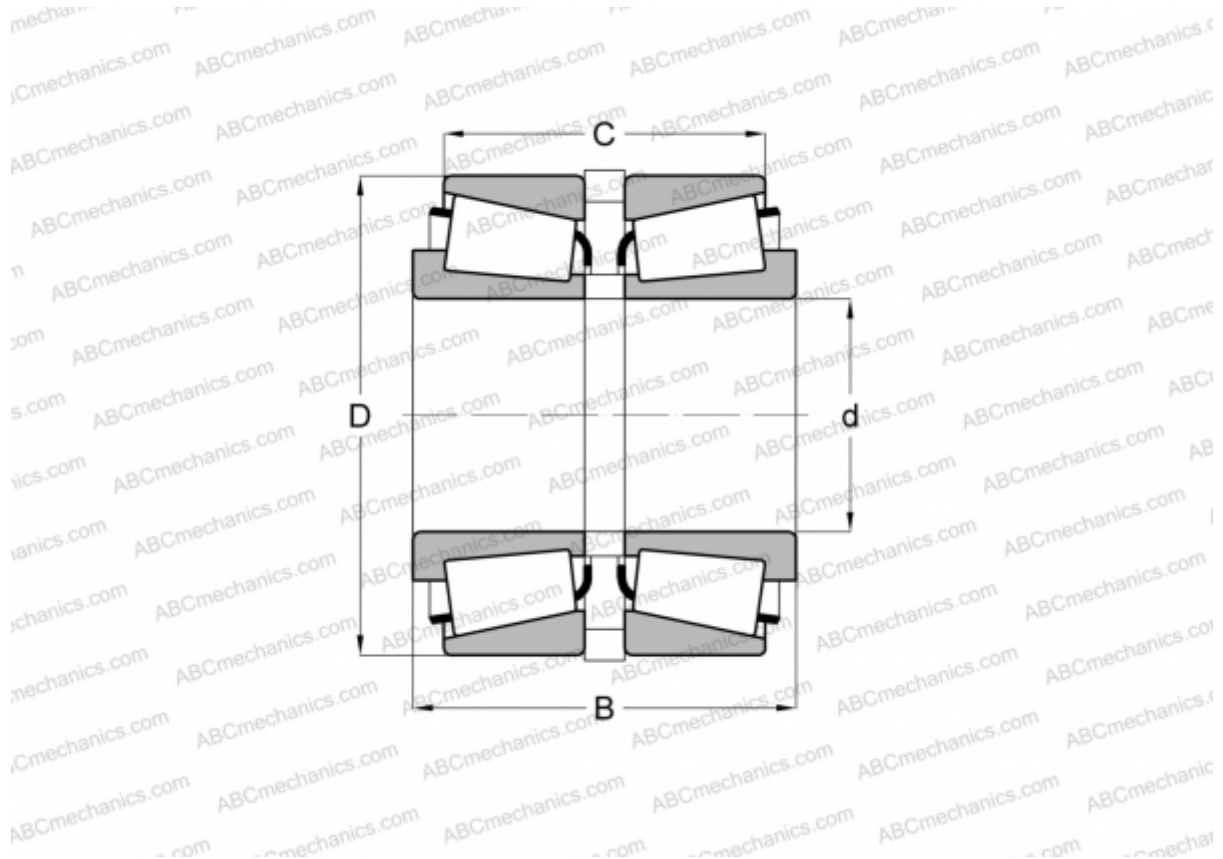

### Technical specification

#### DIMENSIONS, MM

d	38,100
D	65,088
B	39,624
C	31,496

**WEIGHT, KG** 0,480

**MANUFACTURER** [TIMKEN](#)