

28584/28521 + K107577R/K107578R TIMKEN

Tapered roller bearings

TYPE: Roller bearings, Tapered, Tapered roller bearing assembly, Type 2S, two single-row assemblies with snap ring spacer

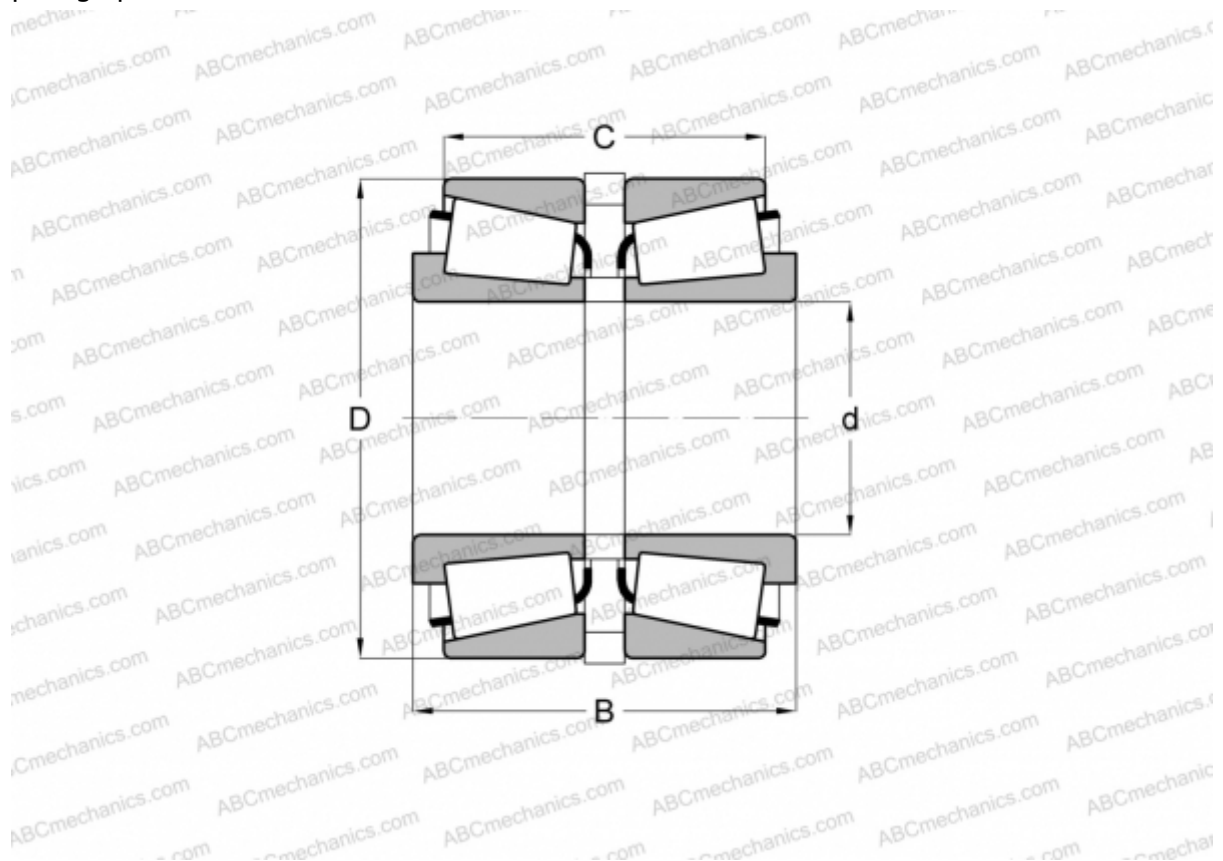

Technical specification

DIMENSIONS, MM

d	52,387
D	92,075
B	54,752
C	45,227

WEIGHT, KG 1,440

MANUFACTURER [TIMKEN](#)