

LM806649/LM806610 + K114294R/K114295R

TIMKEN

Tapered roller bearings

TYPE: Roller bearings, Tapered, Tapered roller bearing assembly, Type 2S, two single-row assemblies with snap ring spacer

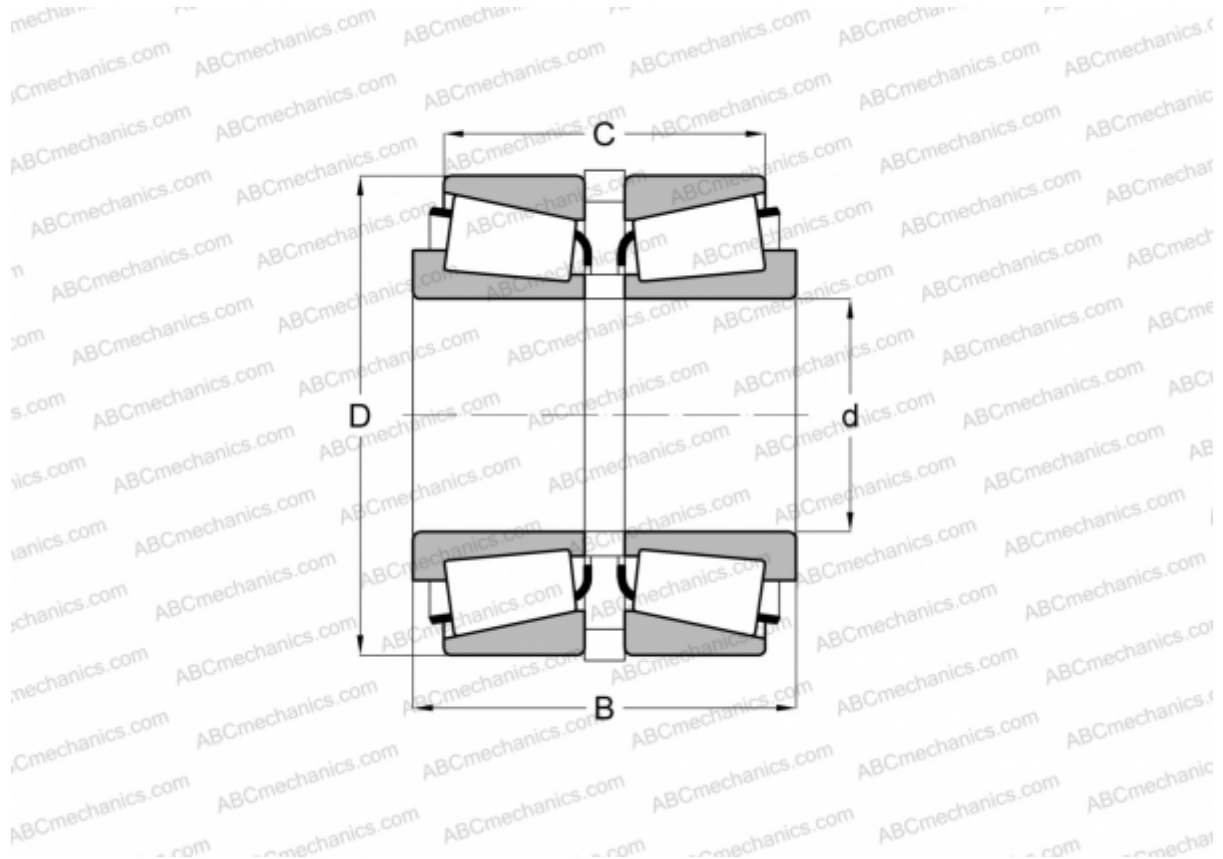

Technical specification

DIMENSIONS, MM

d	53,975
D	88,900
B	43,637
C	32,522

WEIGHT, KG 0,940

MANUFACTURER [TIMKEN](#)