

27690/27620 + K107581R/K107582R TIMKEN

Tapered roller bearings

TYPE: Roller bearings, Tapered, Tapered roller bearing assembly, Type 2S, two single-row assemblies with snap ring spacer

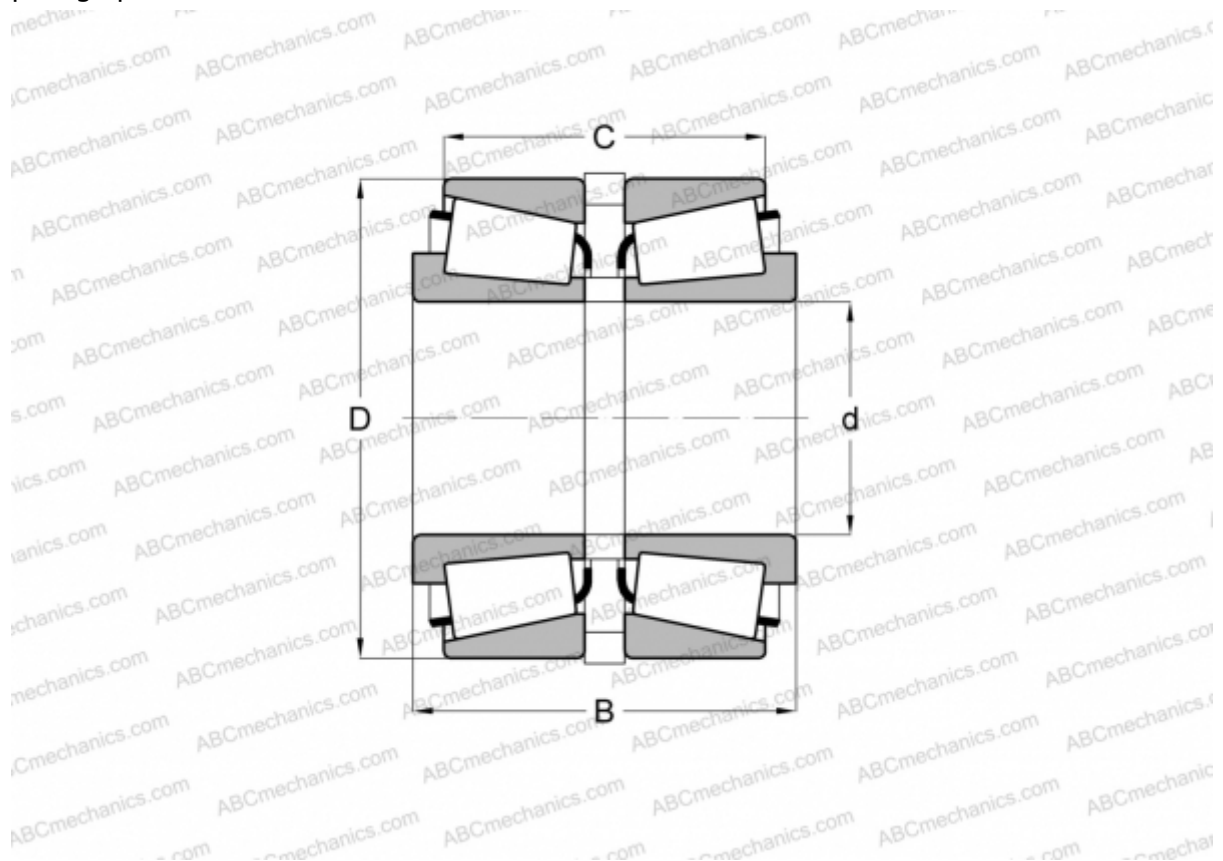

Technical specification

DIMENSIONS, MM

d	83,345
D	125,412
B	54,762
C	43,652

WEIGHT, KG 2,240

MANUFACTURER [TIMKEN](#)