

JLM104948/JLM104910 + K444653R/LM104948XS/LM104910ES TIMKEN

Tapered roller bearings

TYPE: Roller bearings, Tapered, Tapered roller bearing assembly, Type SR, SET-RIGHT TIMKEN, double-row, distance ring, standard clearance

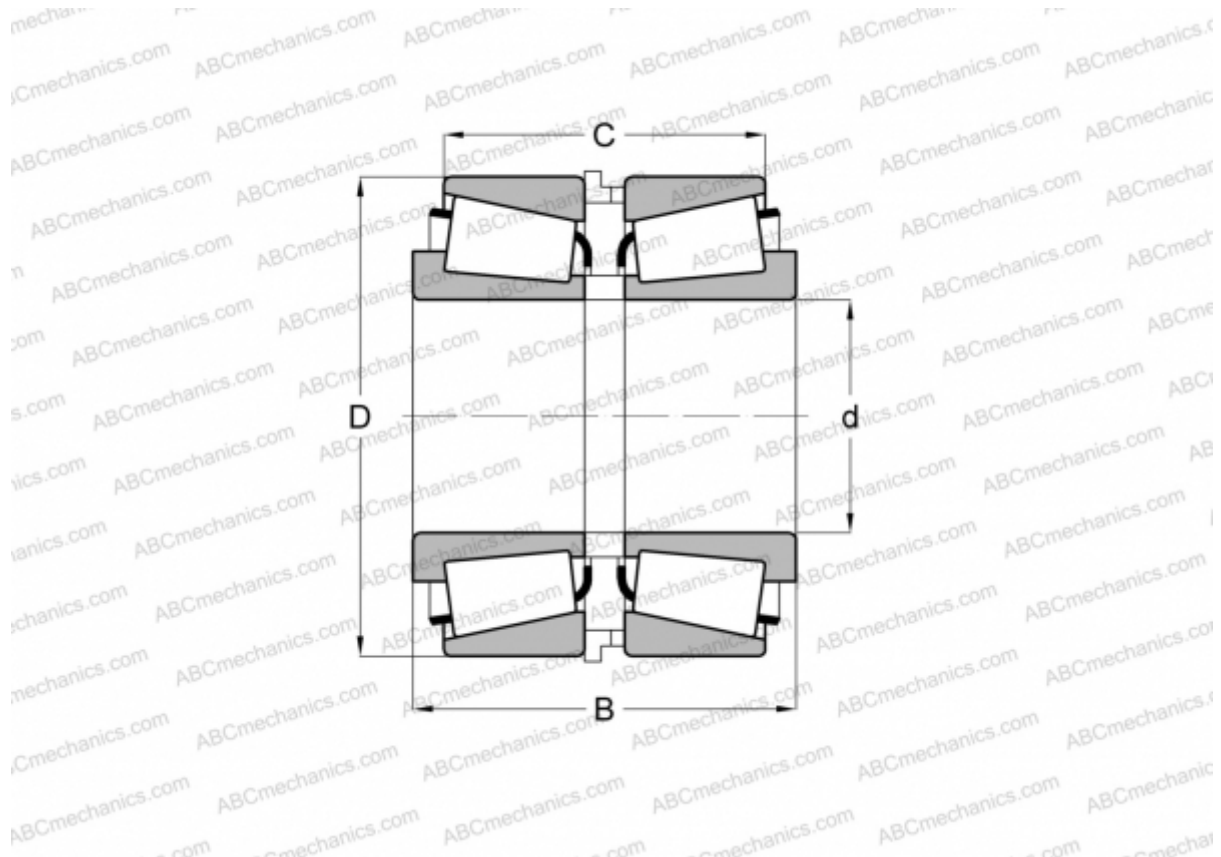

Technical specification

DIMENSIONS, MM

d	50,000
D	82,000
B	49,000
C	39,425

WEIGHT, KG 0,910

MANUFACTURER [TIMKEN](#)