

JLM506849/JLM506810 + K516778R/LM506849XS/LM506810ES TIMKEN

Tapered roller bearings

TYPE: Roller bearings, Tapered, Tapered roller bearing assembly, Type SR, SET-RIGHT TIMKEN, double-row, distance ring, standard clearance

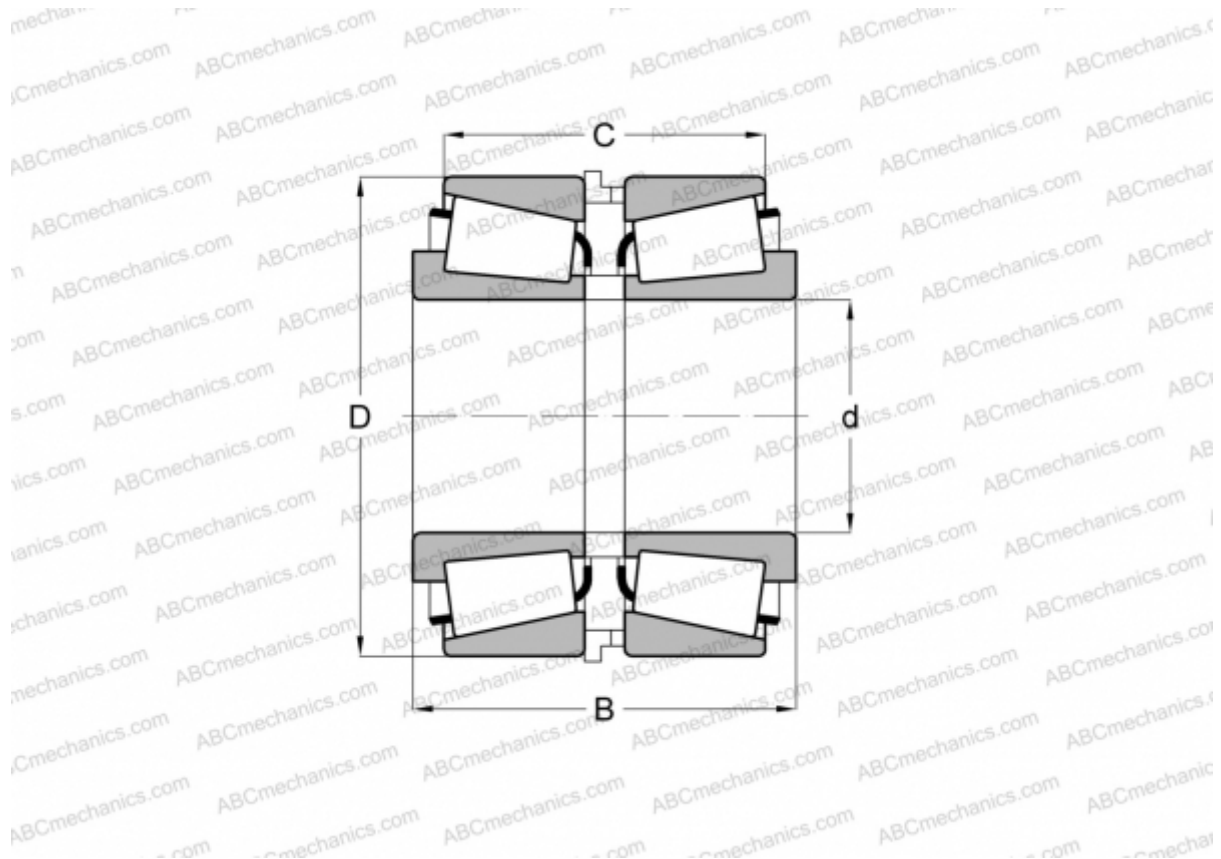

Technical specification

DIMENSIONS, MM

d	55,000
D	90,000
B	52,000
C	42,504

WEIGHT, KG 1,150

MANUFACTURER [TIMKEN](#)