

## JM207049/JM207010 + K518779R/M207049XS/M207010ES TIMKEN

Tapered roller bearings

TYPE: Roller bearings, Tapered, Tapered roller bearing assembly, Type SR, SET-RIGHT TIMKEN, double-row, distance ring, standard clearance

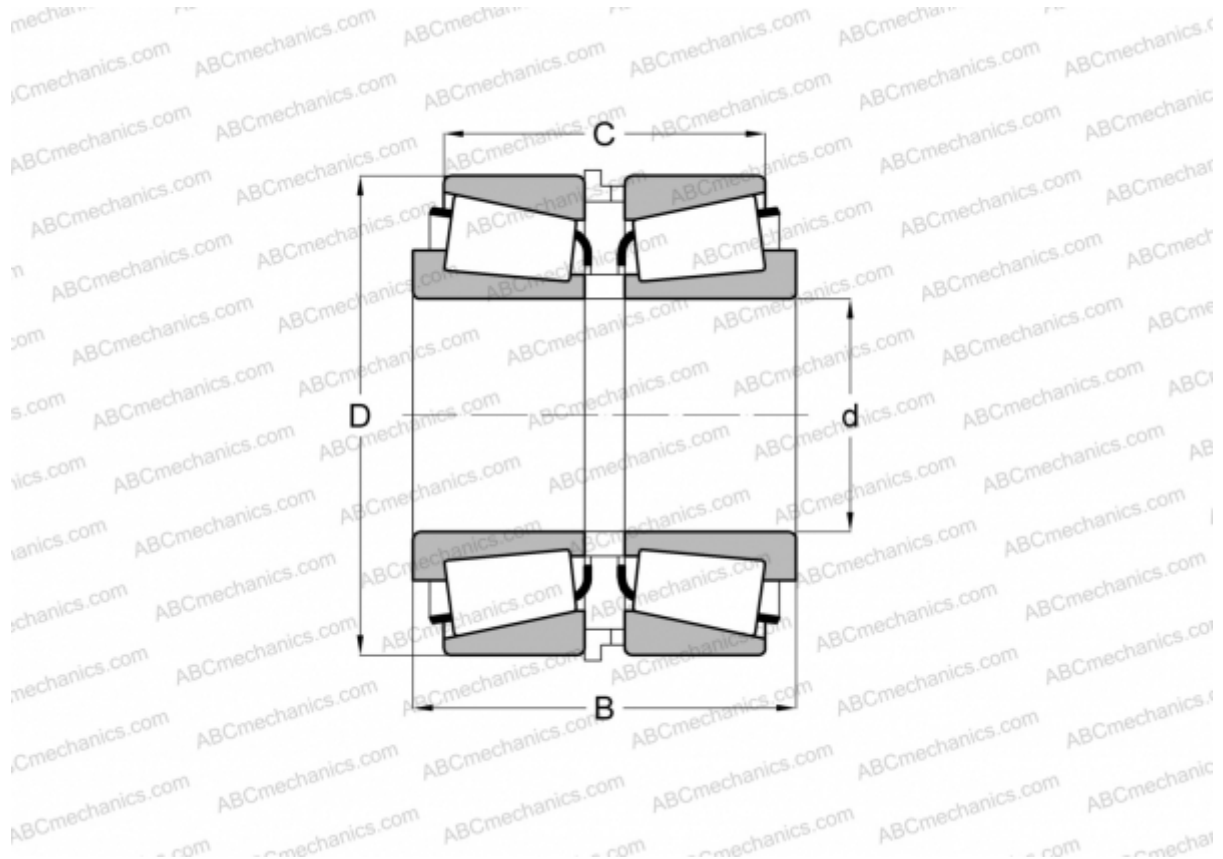

### Technical specification

#### DIMENSIONS, MM

d	55,000
D	95,000
B	64,000
C	52,418

**WEIGHT, KG** 1,740

**MANUFACTURER** [TIMKEN](#)