

JM511946/JM511910 + K518419R/M511946XS/M511910ES TIMKEN

Tapered roller bearings

TYPE: Roller bearings, Tapered, Tapered roller bearing assembly, Type SR, SET-RIGHT TIMKEN, double-row, distance ring, standard clearance

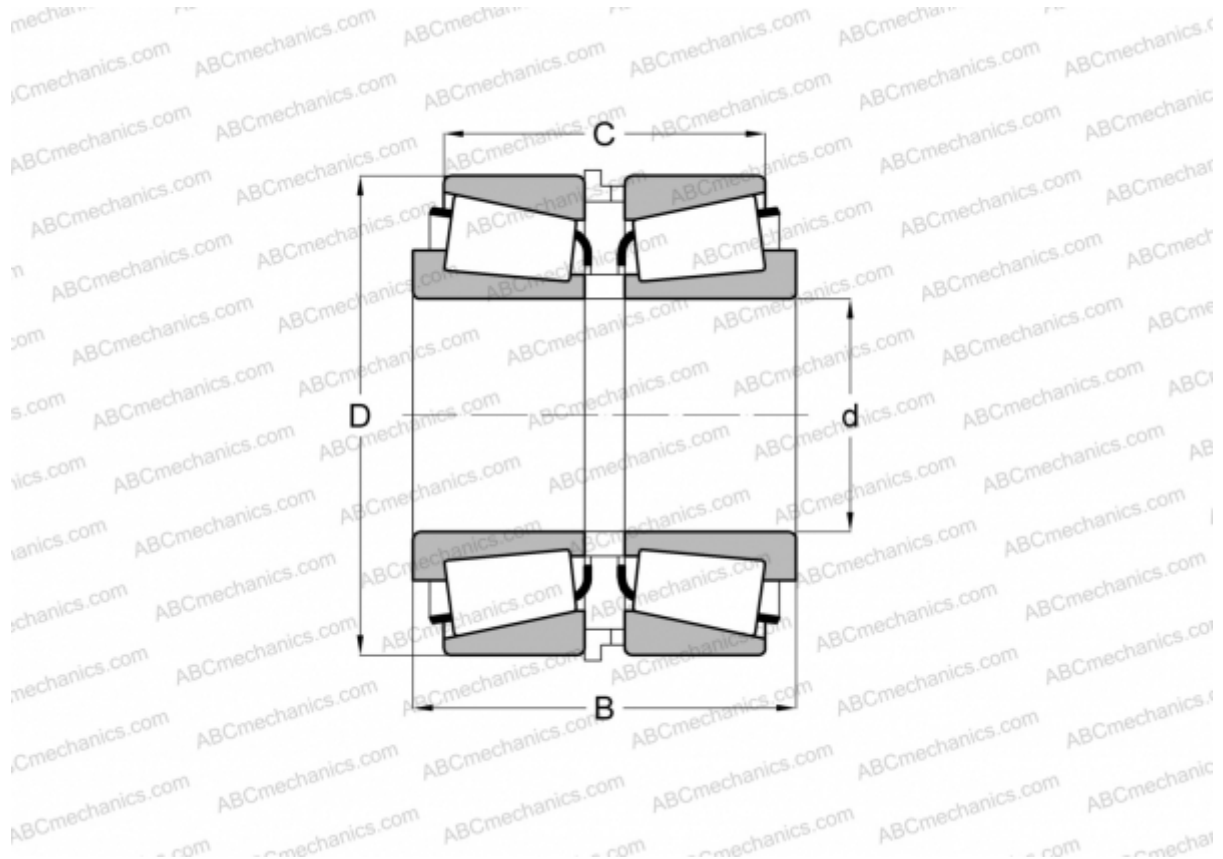

Technical specification

DIMENSIONS, MM

d	65,000
D	110,000
B	62,000
C	50,489

WEIGHT, KG 2,240

MANUFACTURER [TIMKEN](#)