

JLM714149/JLM714110 + K524105R/LM714149XS/LM714110ES TIMKEN

Tapered roller bearings

TYPE: Roller bearings, Tapered, Tapered roller bearing assembly, Type SR, SET-RIGHT TIMKEN, double-row, distance ring, standard clearance

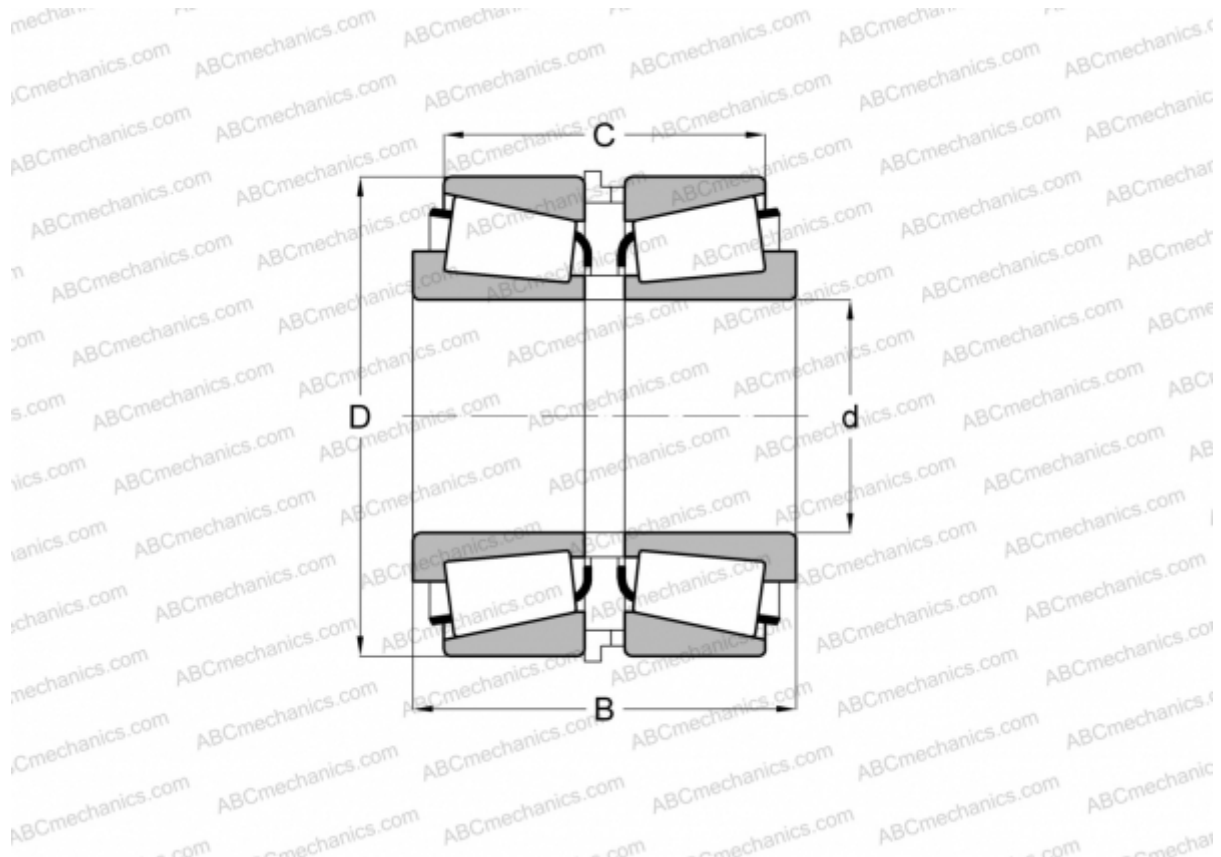

Technical specification

DIMENSIONS, MM

d	75,000
D	115,000
B	56,000
C	43,502

WEIGHT, KG 1,870

MANUFACTURER [TIMKEN](#)