

JM714249/JM714210 + K518771R/M714249XS/M714210ES TIMKEN

Tapered roller bearings

TYPE: Roller bearings, Tapered, Tapered roller bearing assembly, Type SR, SET-RIGHT TIMKEN, double-row, distance ring, standard clearance

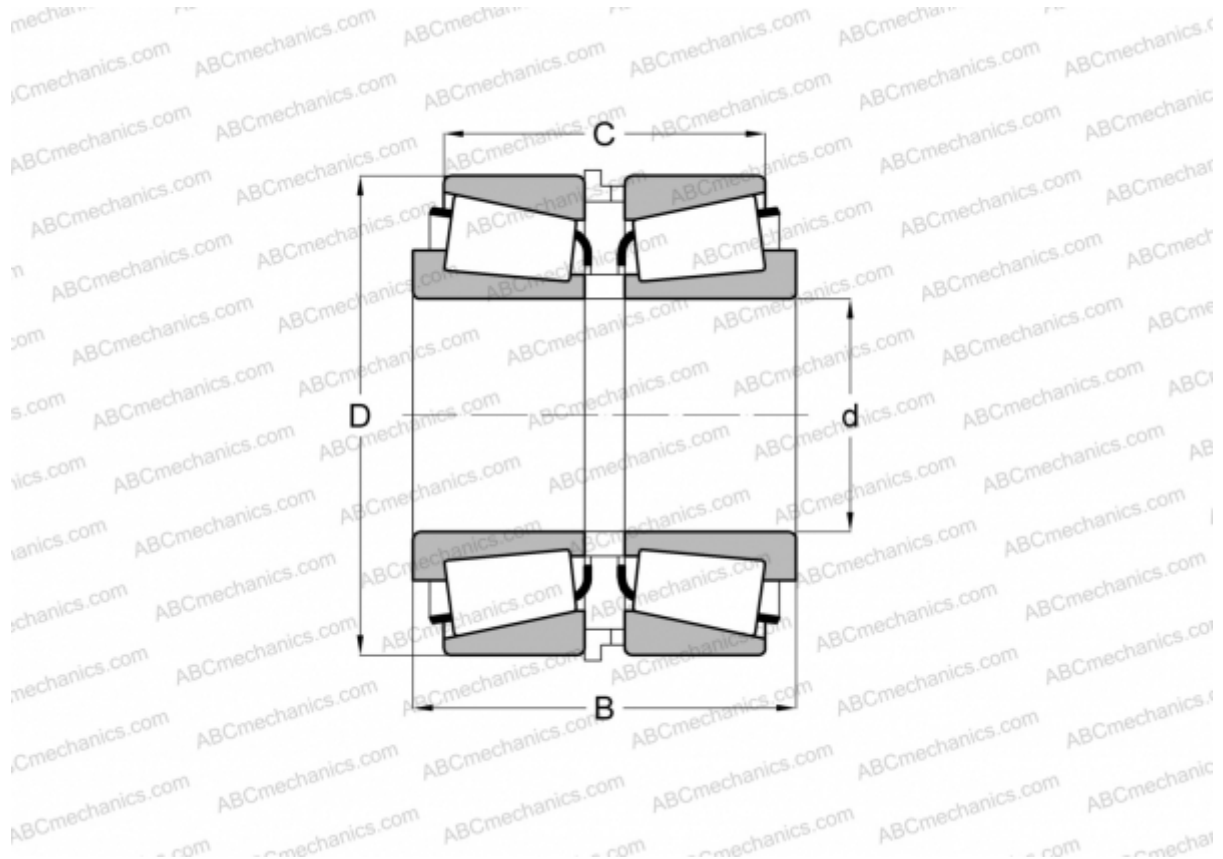

Technical specification

DIMENSIONS, MM

d	75,000
D	120,000
B	69,000
C	57,000

WEIGHT, KG 2,720

MANUFACTURER [TIMKEN](#)