

JH415647/JH415610 + K524653R/H415647XS/H415610ES TIMKEN

Tapered roller bearings

TYPE: Roller bearings, Tapered, Tapered roller bearing assembly, Type SR, SET-RIGHT TIMKEN, double-row, distance ring, standard clearance

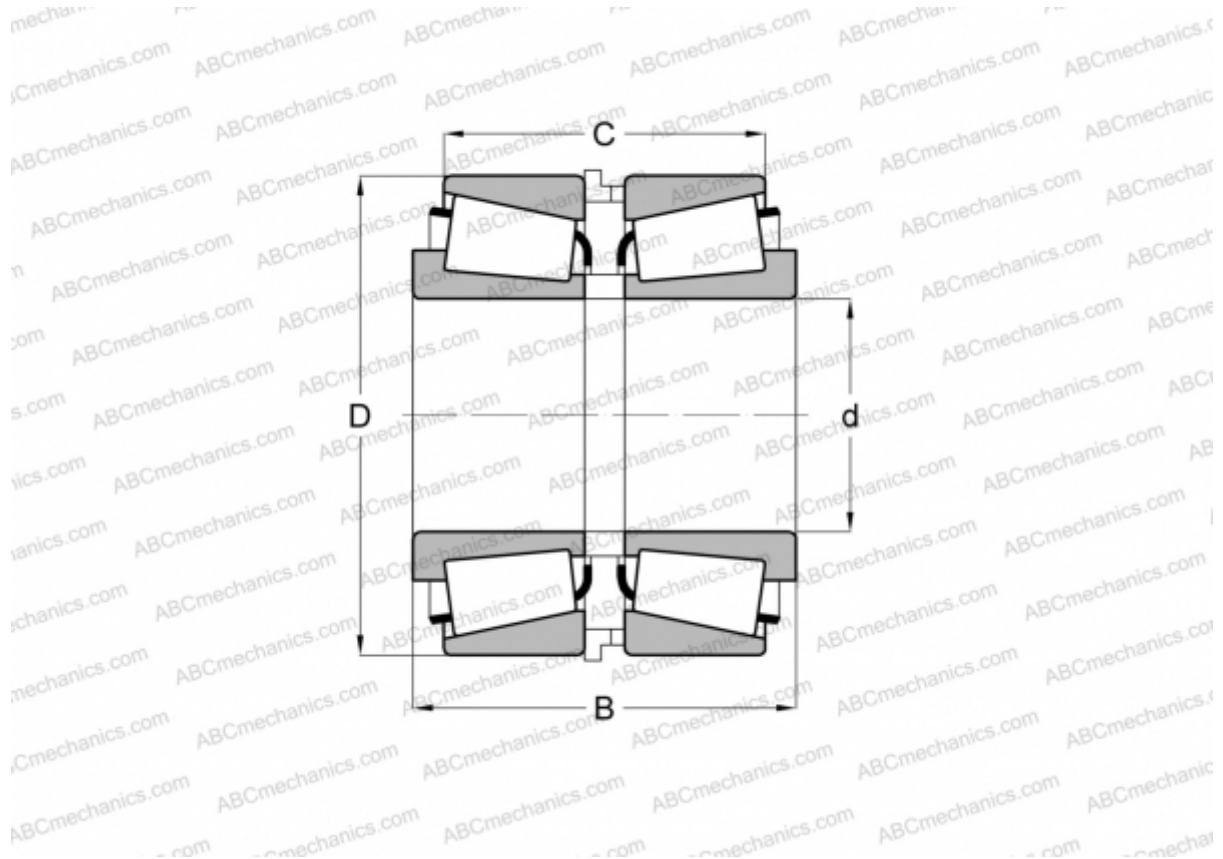

Technical specification

DIMENSIONS, MM

d	75,000
D	145,000
B	112,000
C	93,400

WEIGHT, KG 8,020

MANUFACTURER [TIMKEN](#)