

JM515649/JM515610 + K524112R/M515649XS/M515610ES TIMKEN

Tapered roller bearings

TYPE: Roller bearings, Tapered, Tapered roller bearing assembly, Type SR, SET-RIGHT TIMKEN, double-row, distance ring, standard clearance

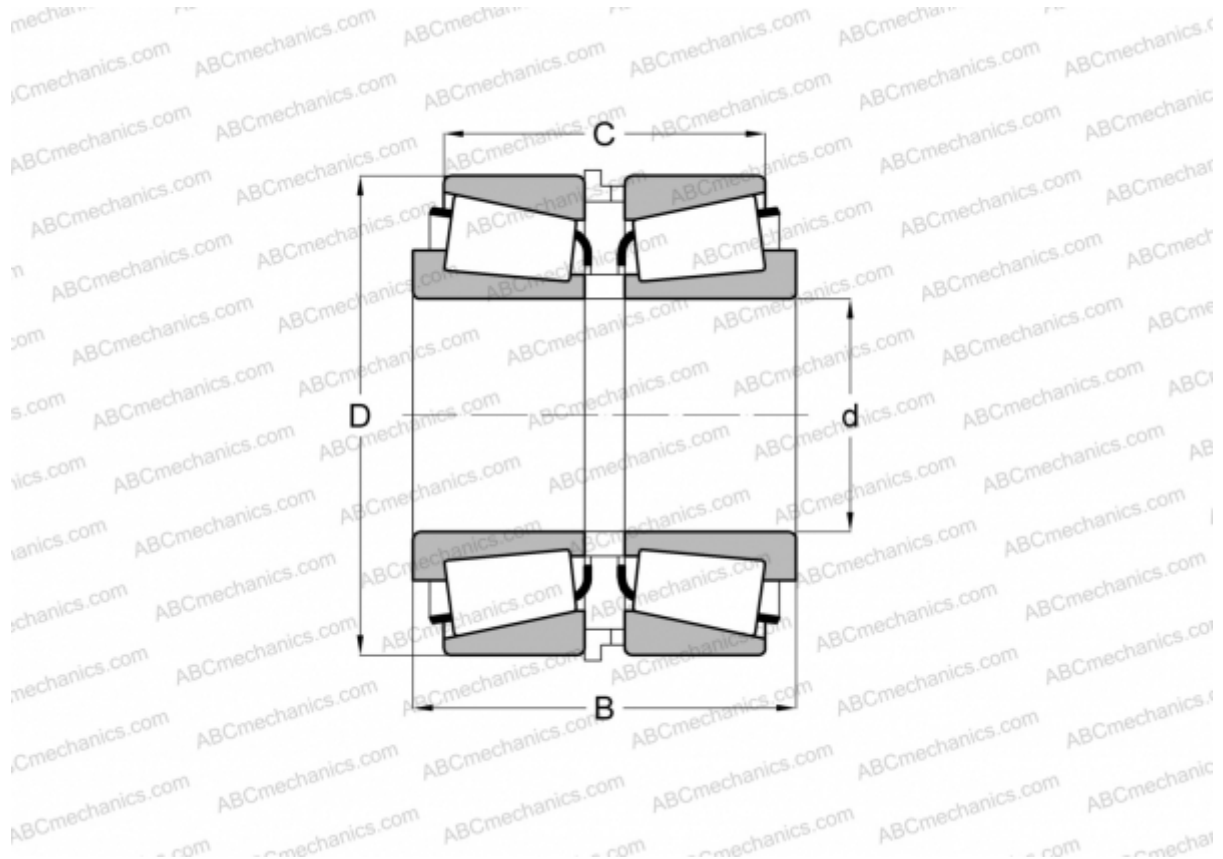

Technical specification

DIMENSIONS, MM

d	80,000
D	130,000
B	78,000
C	64,452

WEIGHT, KG 3,620

MANUFACTURER [TIMKEN](#)