

JM716649/JM716610 + K523970R/M716649XS/M716610ES TIMKEN

Tapered roller bearings

TYPE: Roller bearings, Tapered, Tapered roller bearing assembly, Type SR, SET-RIGHT TIMKEN, double-row, distance ring, standard clearance

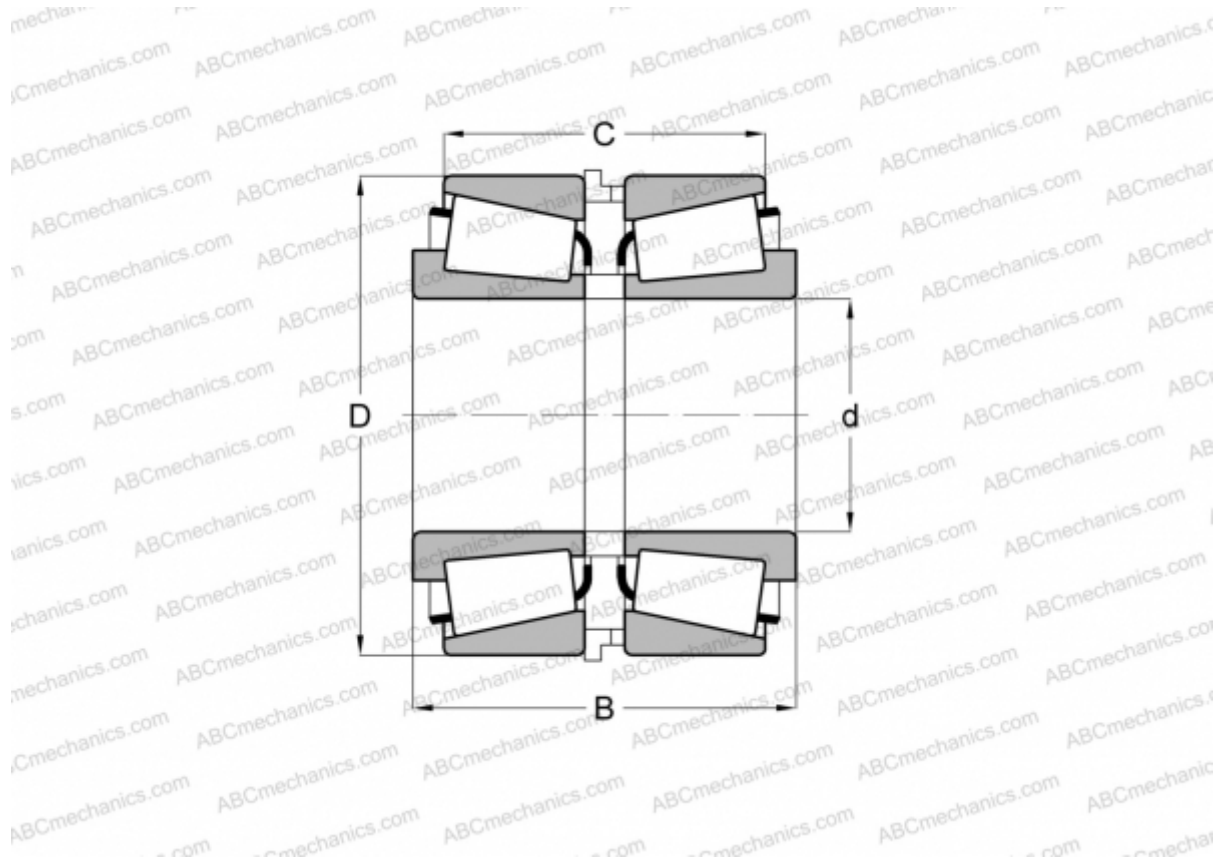

Technical specification

DIMENSIONS, MM

d	85,000
D	130,000
B	65,975
C	53,491

WEIGHT, KG 2,870

MANUFACTURER [TIMKEN](#)