

## JM718149/JM718110 + K524653R/M718149XS/M718110ES TIMKEN

Tapered roller bearings

TYPE: Roller bearings, Tapered, Tapered roller bearing assembly, Type SR, SET-RIGHT TIMKEN, double-row, distance ring, standard clearance

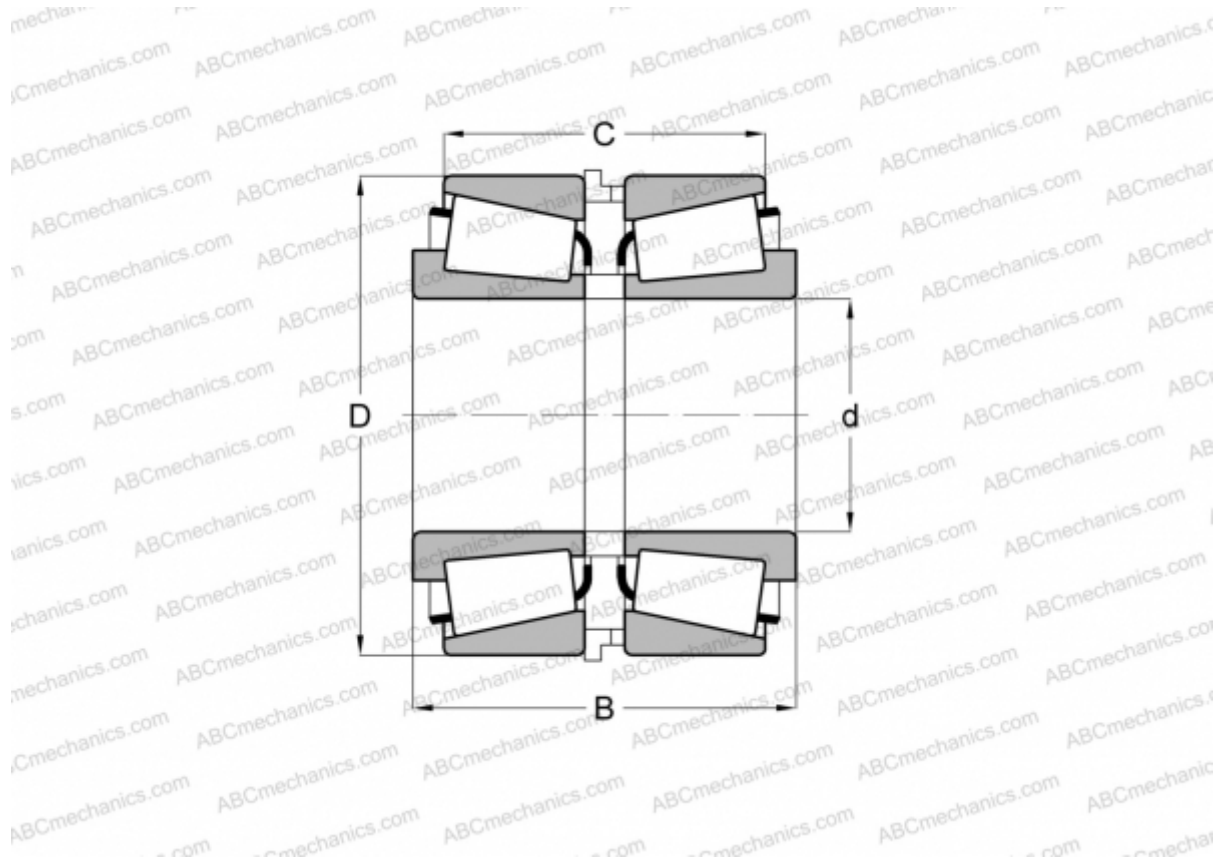

### Technical specification

#### DIMENSIONS, MM

d	90,000
D	145,000
B	78,974
C	62,489

**WEIGHT, KG** 4,590

**MANUFACTURER** [TIMKEN](#)