

## JM719149/JM719113 + K518773R/M719149XS/M719113ES TIMKEN

Tapered roller bearings

TYPE: Roller bearings, Tapered, Tapered roller bearing assembly, Type SR, SET-RIGHT TIMKEN, double-row, distance ring, standard clearance

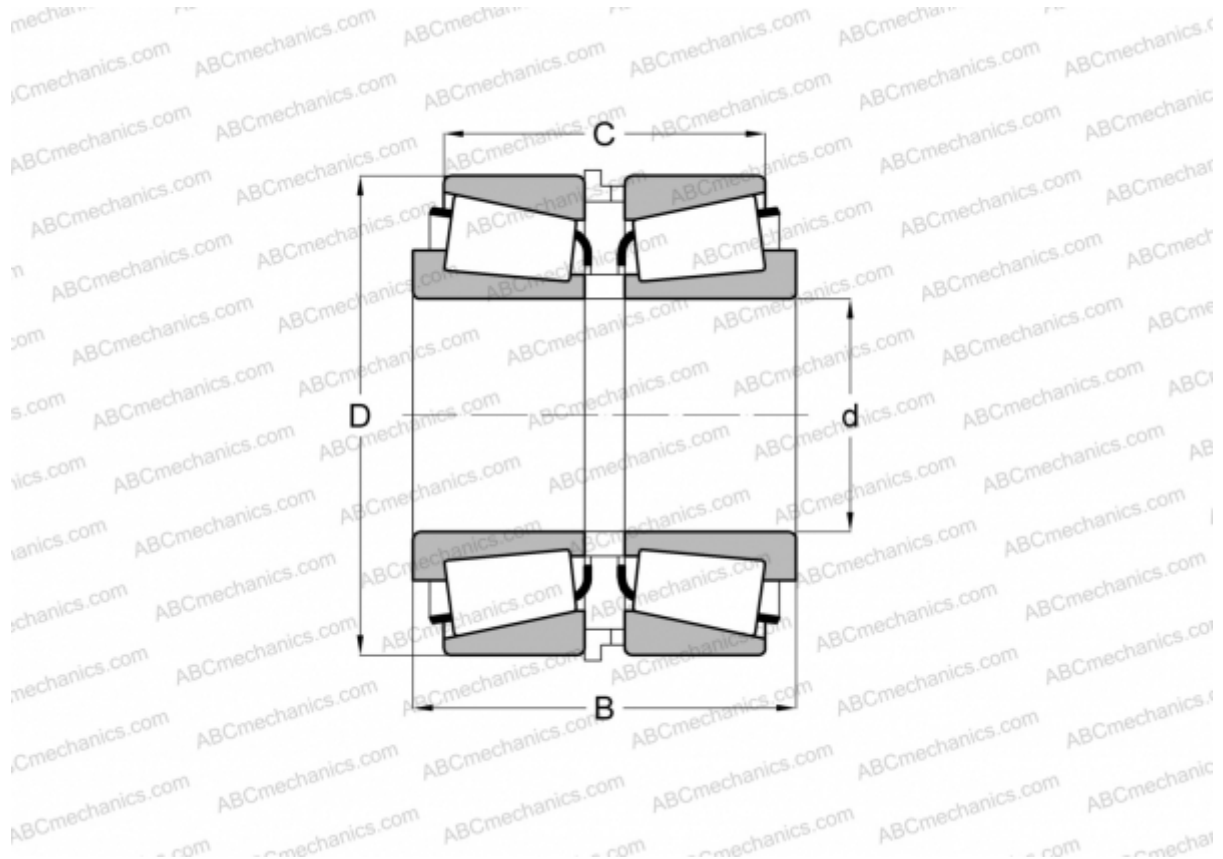

### Technical specification

#### DIMENSIONS, MM

d	95,000
D	150,000
B	78,000
C	61,466

**WEIGHT, KG** 4,600

**MANUFACTURER** [TIMKEN](#)