

JHM522649/JHM522610 + K518334R/HM522649XS/HM522610ES TIMKEN

Tapered roller bearings

TYPE: Roller bearings, Tapered, Tapered roller bearing assembly, Type SR, SET-RIGHT TIMKEN, double-row, distance ring, standard clearance

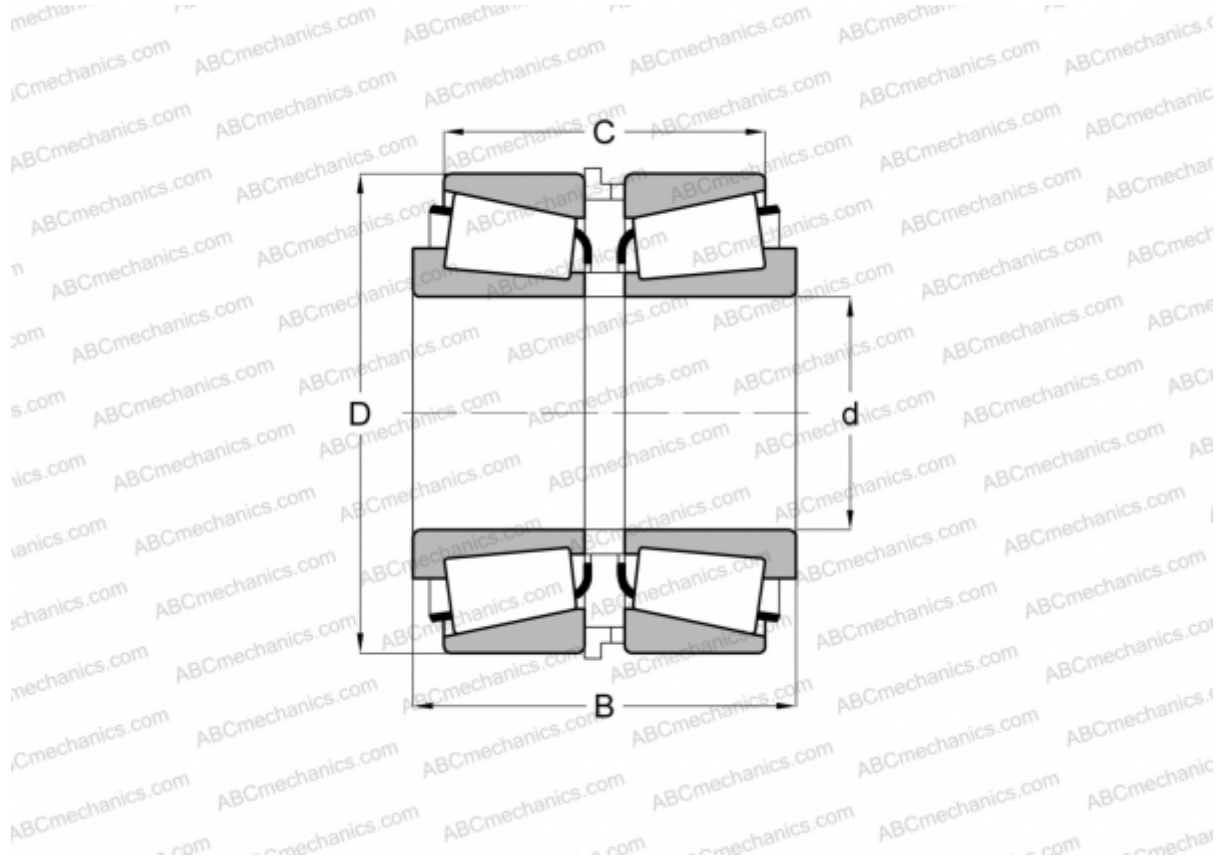

Technical specification

DIMENSIONS, MM

d	110,000
D	180,000
B	102,975
C	84,364

WEIGHT, KG 9,420

MANUFACTURER [TIMKEN](#)