

## JM738249/JM738210 + K525378R/M738249XS/M738210ES TIMKEN

Tapered roller bearings

TYPE: Roller bearings, Tapered, Tapered roller bearing assembly, Type SR, SET-RIGHT TIMKEN, double-row, distance ring, standard clearance

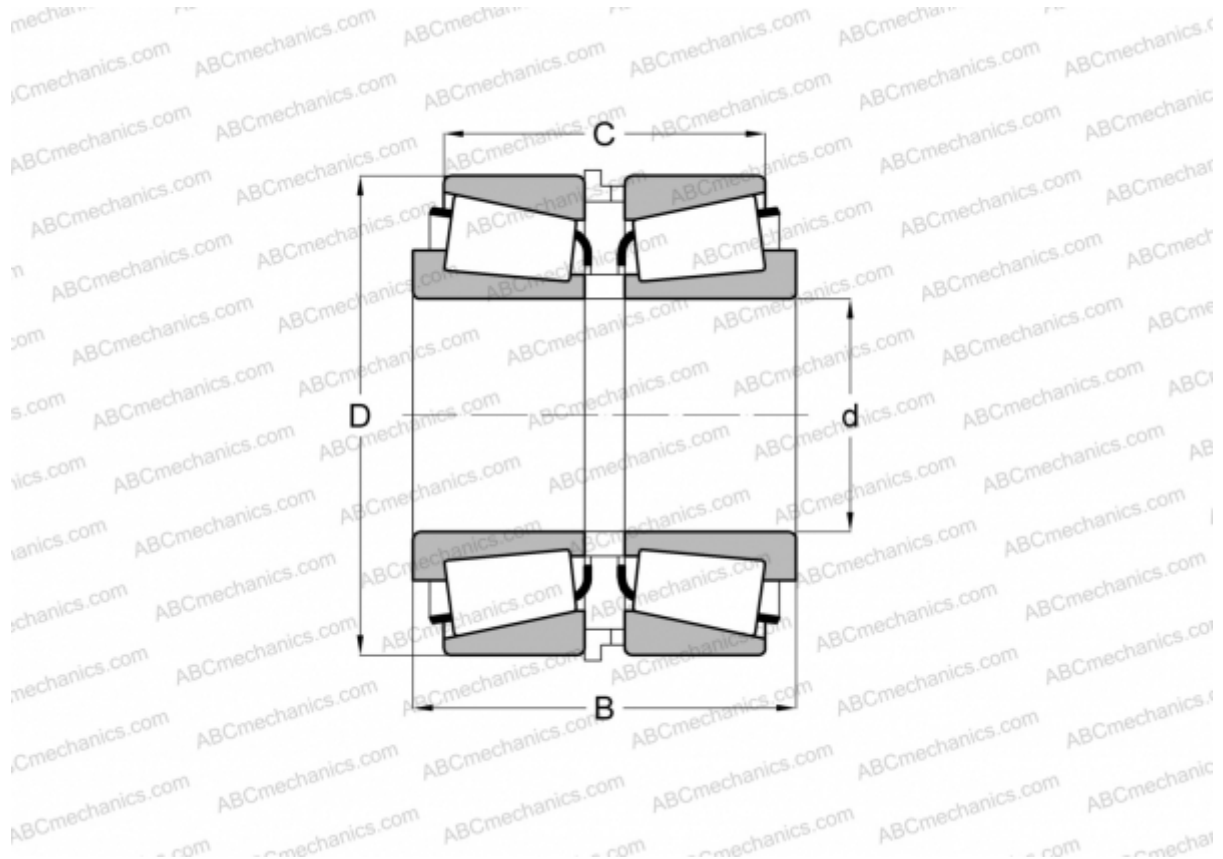

### Technical specification

#### DIMENSIONS, MM

d	190,000
D	260,000
B	102,000
C	82,263

**WEIGHT, KG** 14,410

**MANUFACTURER** [TIMKEN](#)