

3382/3339 + X1S-3382 TIMKEN

Tapered roller bearings

TYPE: Roller bearings, Tapered, Tapered roller bearing assembly, Type 2TS-IM (X-mounting), two single row bearing with inner and outer distance rings

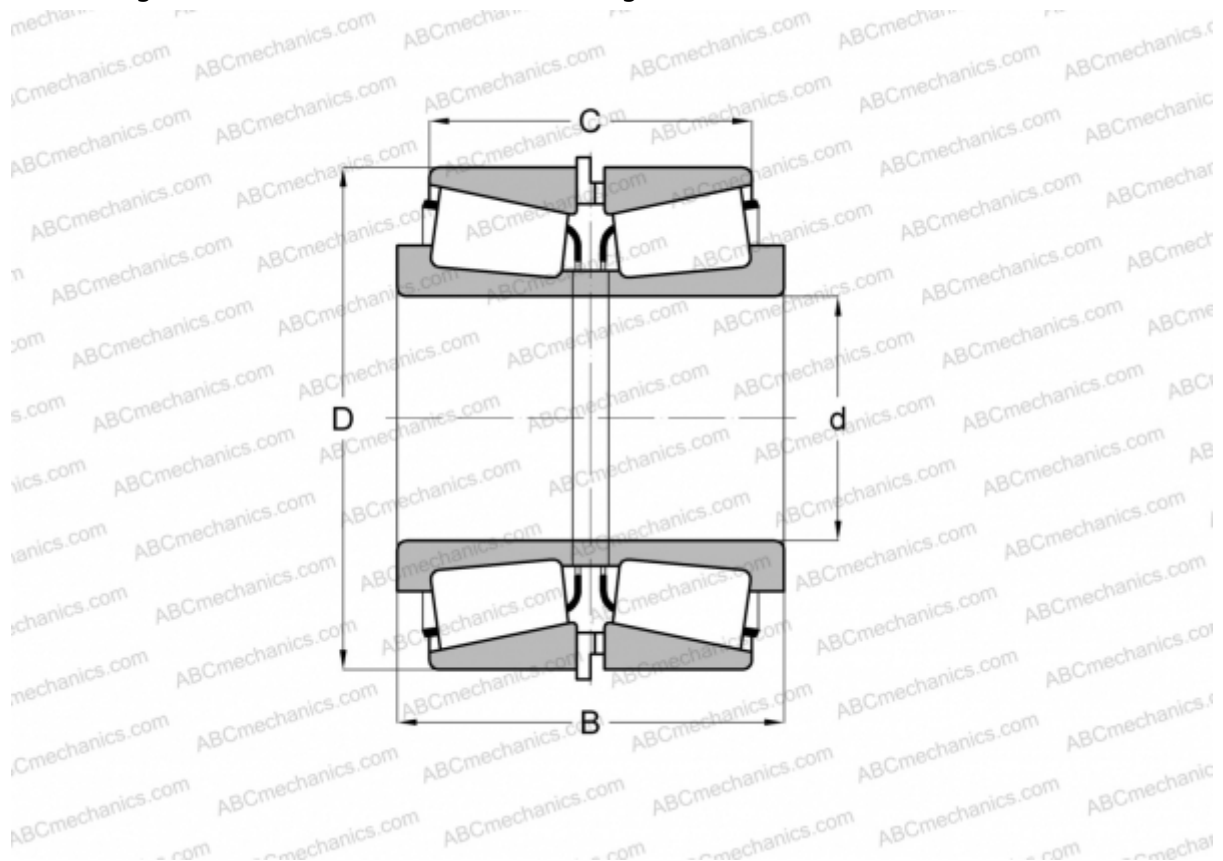

Technical specification

DIMENSIONS, MM

d	39,688
D	80,035
B	87,315
C	76,200

WEIGHT, KG 1,400

MANUFACTURER [TIMKEN](#)