

3880/3820 + X1S-3880/Y7S-3820 TIMKEN

Tapered roller bearings

TYPE: Roller bearings, Tapered, Tapered roller bearing assembly, Type 2TS-IM (X-mounting), two single row bearing with inner and outer distance rings

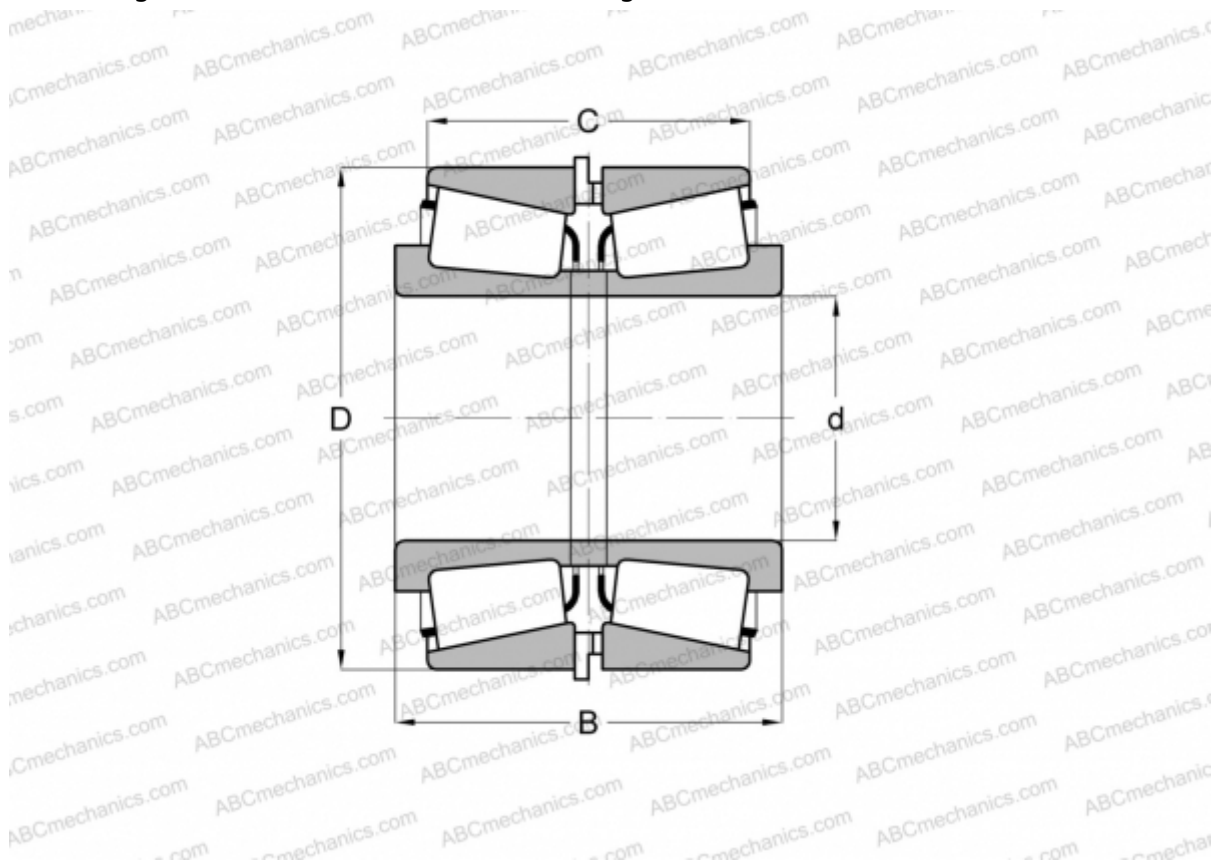

Technical specification

DIMENSIONS, MM

d	41,275
D	85,725
B	66,675
C	53,975

WEIGHT, KG 1,710

MANUFACTURER [TIMKEN](#)