

4395/4335 + X1S-4395/Y1S-4335 TIMKEN

Tapered roller bearings

TYPE: Roller bearings, Tapered, Tapered roller bearing assembly, Type 2TS-IM (X-mounting), two single row bearing with inner and outer distance rings

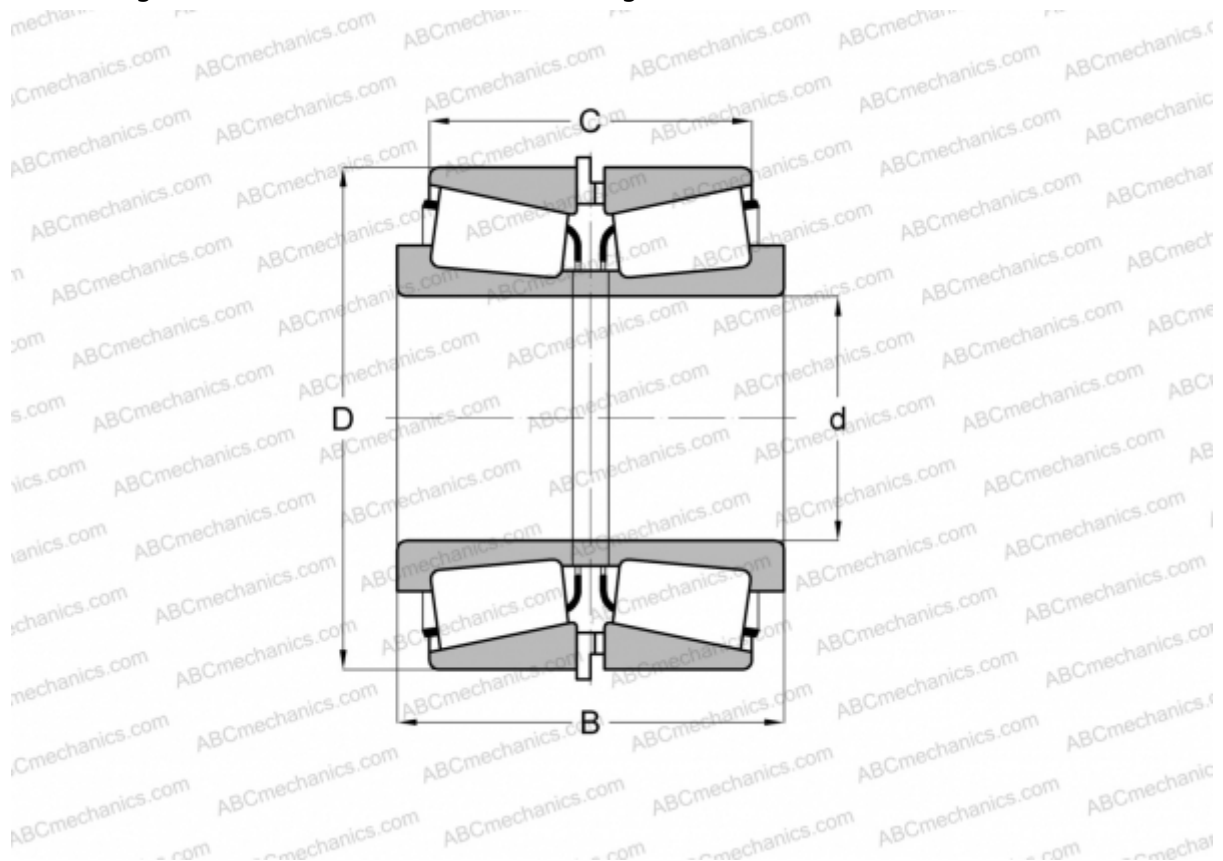

Technical specification

DIMENSIONS, MM

d	42,070
D	90,488
B	87,376
C	74,676

WEIGHT, KG 2,600

MANUFACTURER [TIMKEN](#)