

529/522 + X1S-529/Y1S-522 TIMKEN

Tapered roller bearings

TYPE: Roller bearings, Tapered, Tapered roller bearing assembly, Type 2TS-IM (X-mounting), two single row bearing with inner and outer distance rings

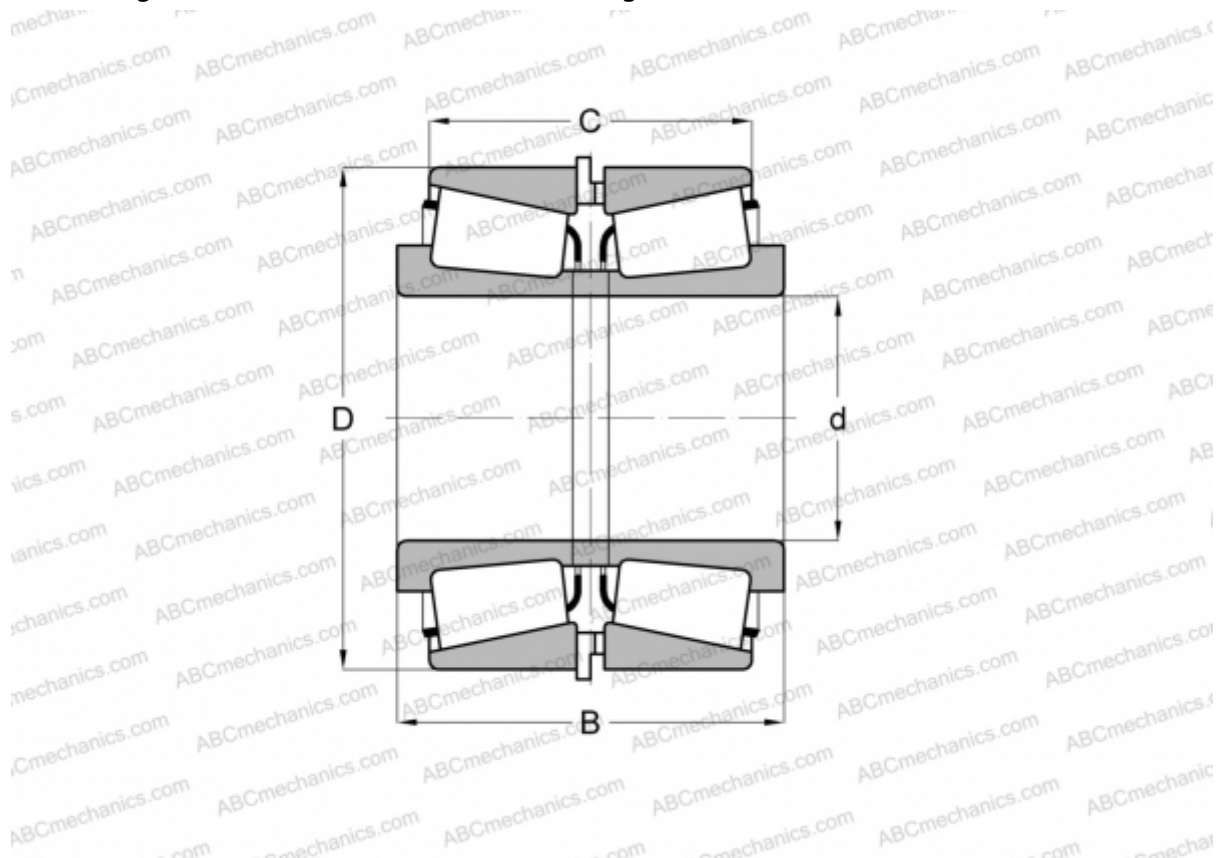

Technical specification

DIMENSIONS, MM

d	50,800
D	101,600
B	78,580
C	62,705

WEIGHT, KG 2,610

MANUFACTURER [TIMKEN](#)