

65200/65500 + X1S-65200/Y1S-65500

TIMKEN

Tapered roller bearings

TYPE: Roller bearings, Tapered, Tapered roller bearing assembly, Type 2TS-IM (X-mounting), two single row bearing with inner and outer distance rings

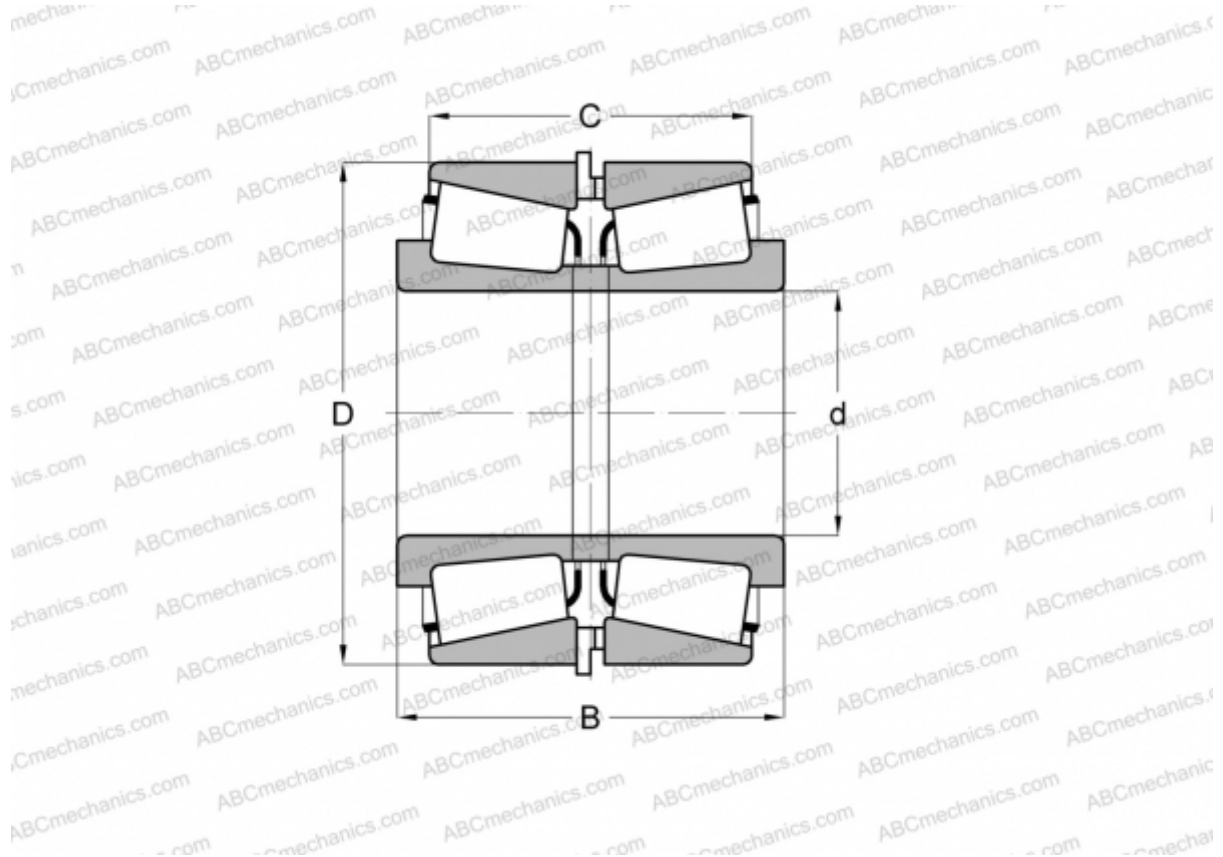

Technical specification

DIMENSIONS, MM

d	50,800
D	127,000
B	95,250
C	76,200

WEIGHT, KG 6,060

MANUFACTURER [TIMKEN](#)