

9285/9220 + X2S-9285/Y3S-9220 TIMKEN

Tapered roller bearings

TYPE: Roller bearings, Tapered, Tapered roller bearing assembly, Type 2TS-IM (X-mounting), two single row bearing with inner and outer distance rings

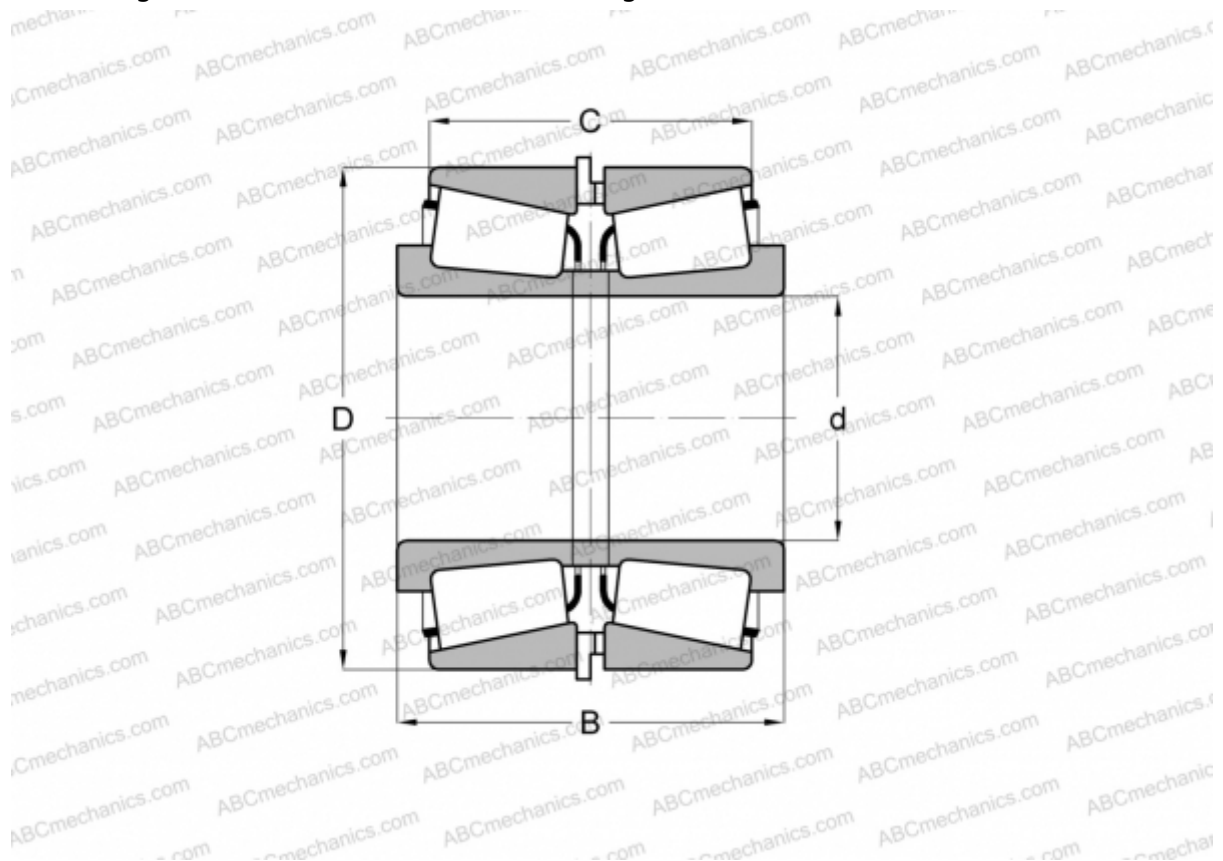

Technical specification

DIMENSIONS, MM

d	76,200
D	161,925
B	107,950
C	73,025

WEIGHT, KG 8,930

MANUFACTURER [TIMKEN](#)