

6575/6535 + X1S-6575/Y1S-6535 TIMKEN

Tapered roller bearings

TYPE: Roller bearings, Tapered, Tapered roller bearing assembly, Type 2TS-IM (X-mounting), two single row bearing with inner and outer distance rings

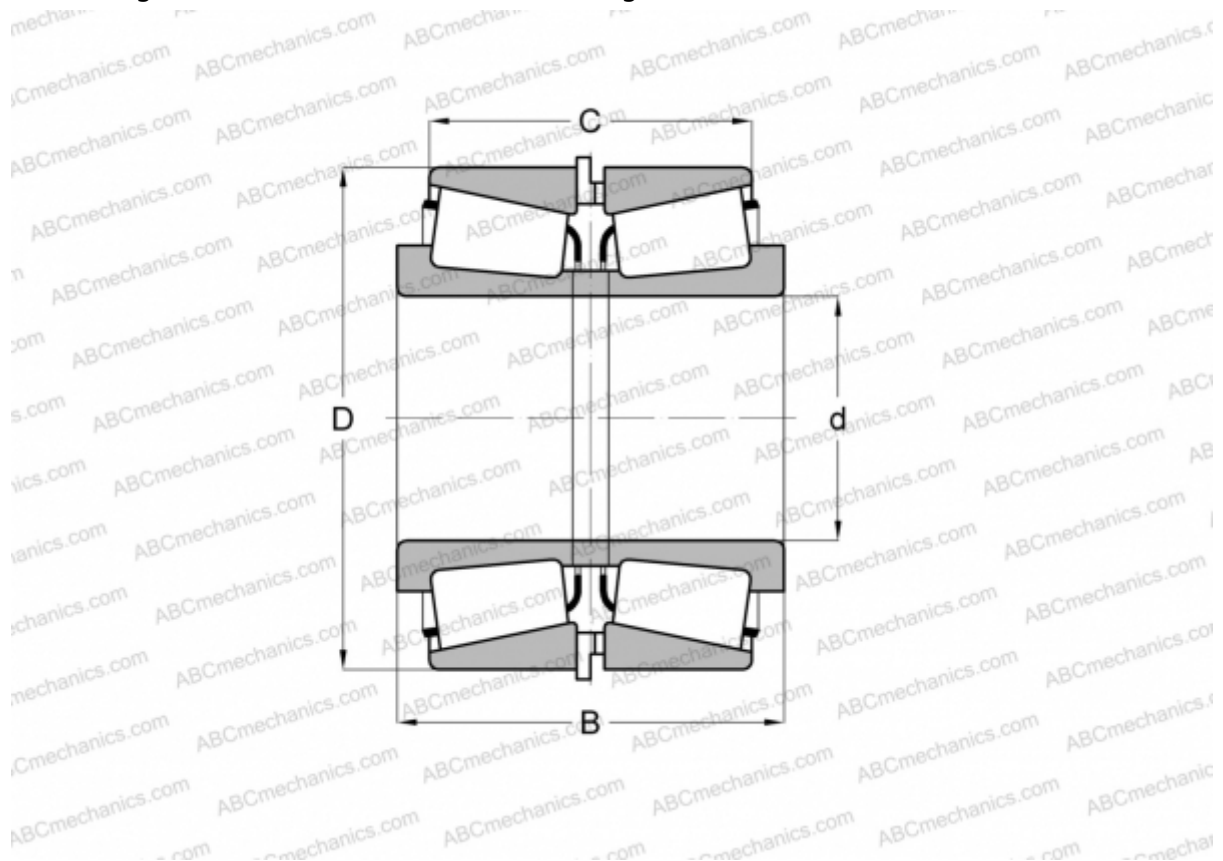

Technical specification

DIMENSIONS, MM

d	76,200
D	161,925
B	115,888
C	93,662

WEIGHT, KG 11,200

MANUFACTURER [TIMKEN](#)