

## 90334/90744 + X1S-90334/Y4S-90744

### TIMKEN

Tapered roller bearings

TYPE: Roller bearings, Tapered, Tapered roller bearing assembly, Type 2TS-IM (X-mounting), two single row bearing with inner and outer distance rings

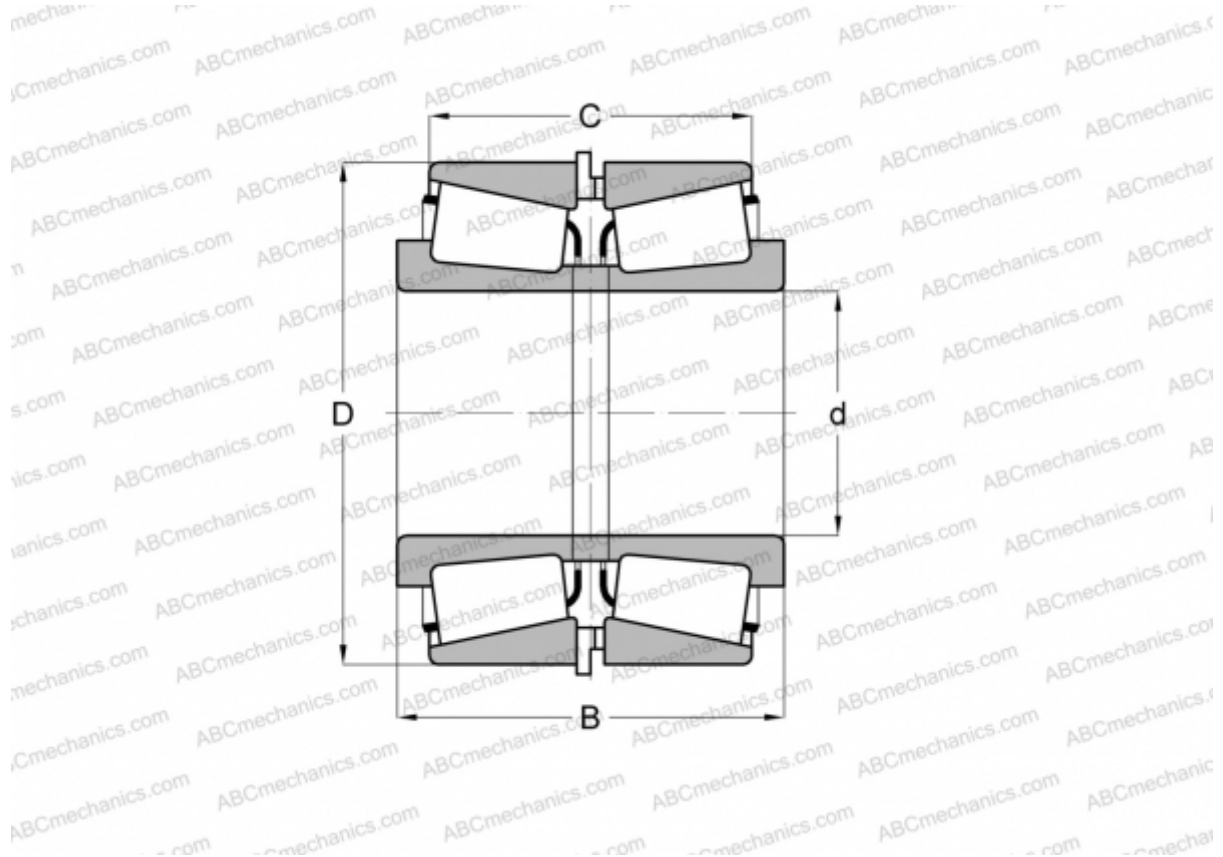

### Technical specification

#### DIMENSIONS, MM

d	85,000
D	188,912
B	112,944
C	69,850

**WEIGHT, KG** 13,590

**MANUFACTURER** [TIMKEN](#)