

677/672 + X2S-677/Y5S-672 TIMKEN

Tapered roller bearings

TYPE: Roller bearings, Tapered, Tapered roller bearing assembly, Type 2TS-IM (X-mounting), two single row bearing with inner and outer distance rings

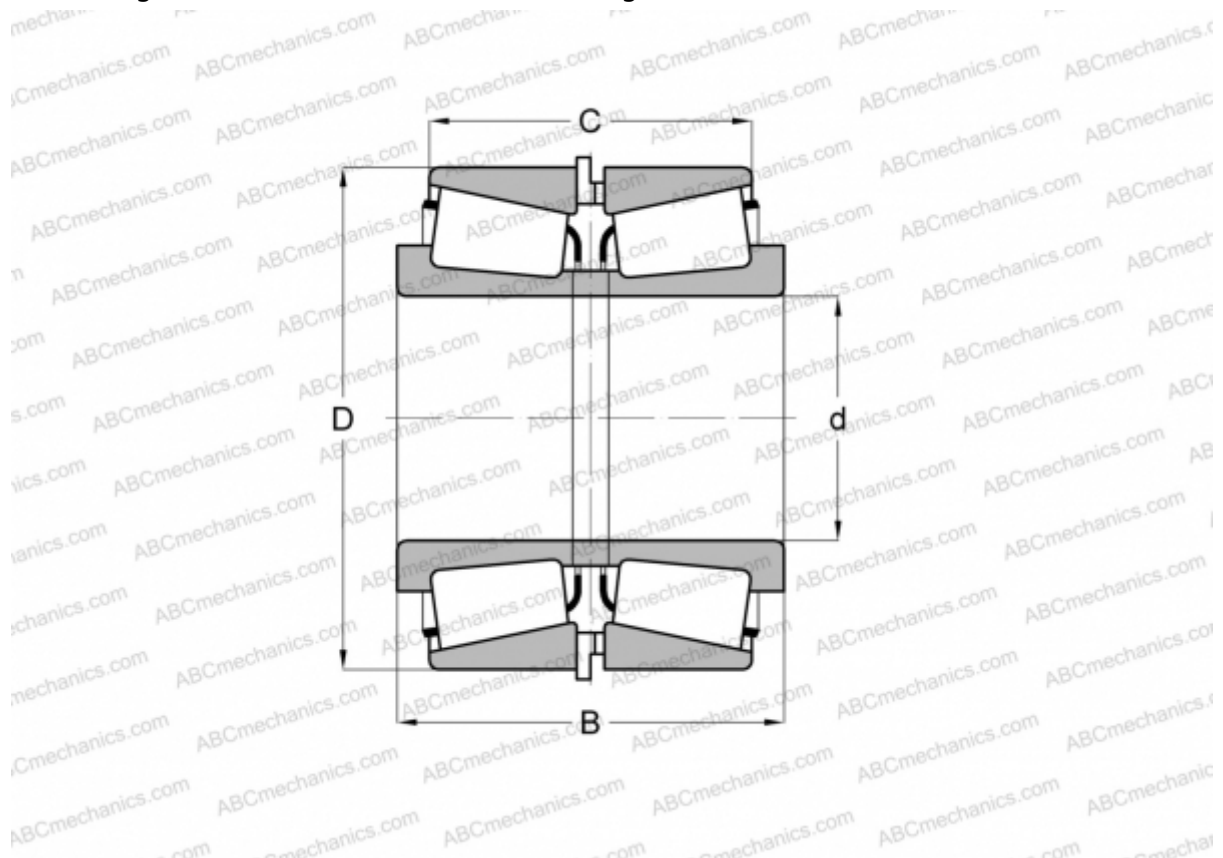

Technical specification

DIMENSIONS, MM

d	85,725
D	168,275
B	184,125
C	161,925

WEIGHT, KG 14,070

MANUFACTURER [TIMKEN](#)