

850/832 + X4S-850/Y3S-832 TIMKEN

Tapered roller bearings

TYPE: Roller bearings, Tapered, Tapered roller bearing assembly, Type 2TS-IM (X-mounting), two single row bearing with inner and outer distance rings

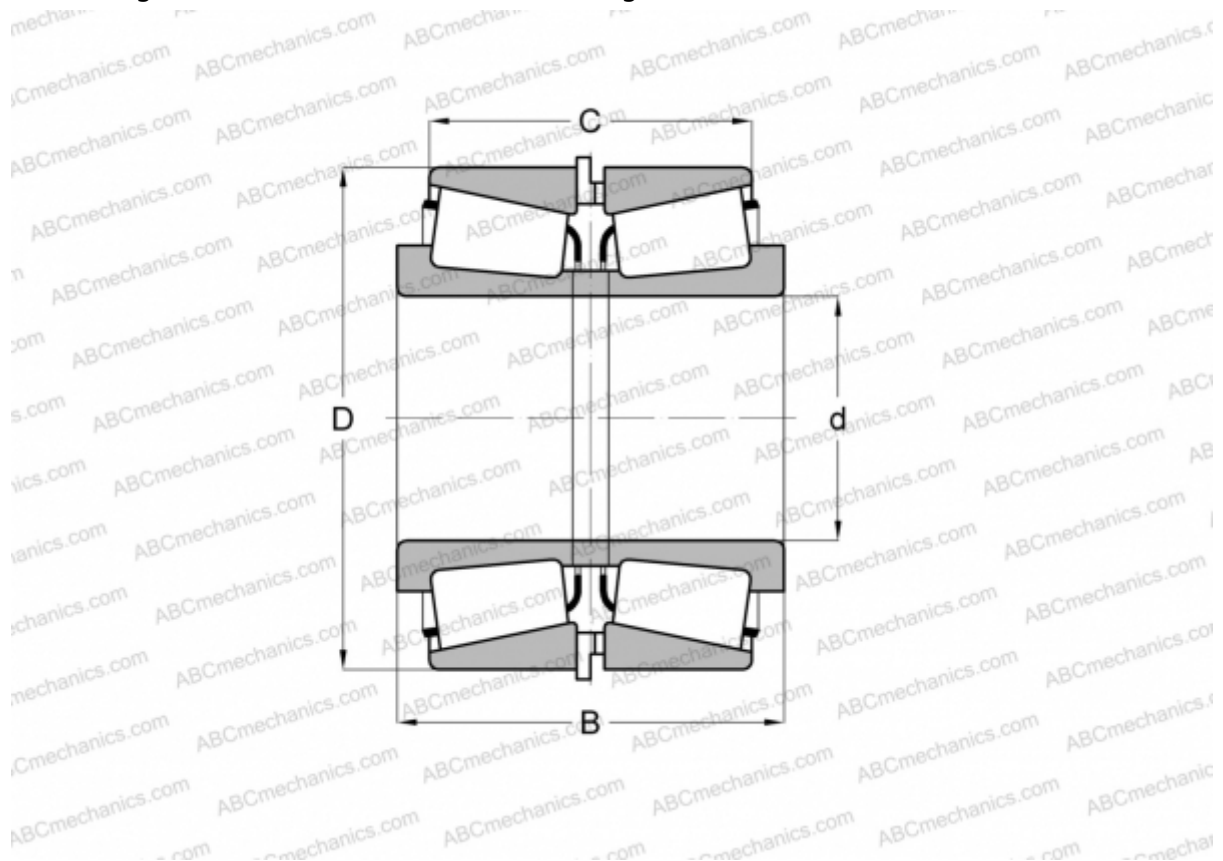

Technical specification

DIMENSIONS, MM

d	88,900
D	168,275
B	122,212
C	96,812

WEIGHT, KG 10,640

MANUFACTURER [TIMKEN](#)