

JM718149/JM718110 + M718149XA/M718110ES TIMKEN

Tapered roller bearings

TYPE: Roller bearings, Tapered, Tapered roller bearing assembly, Type 2TS-IM (X-mounting), two single row bearing with inner and outer distance rings

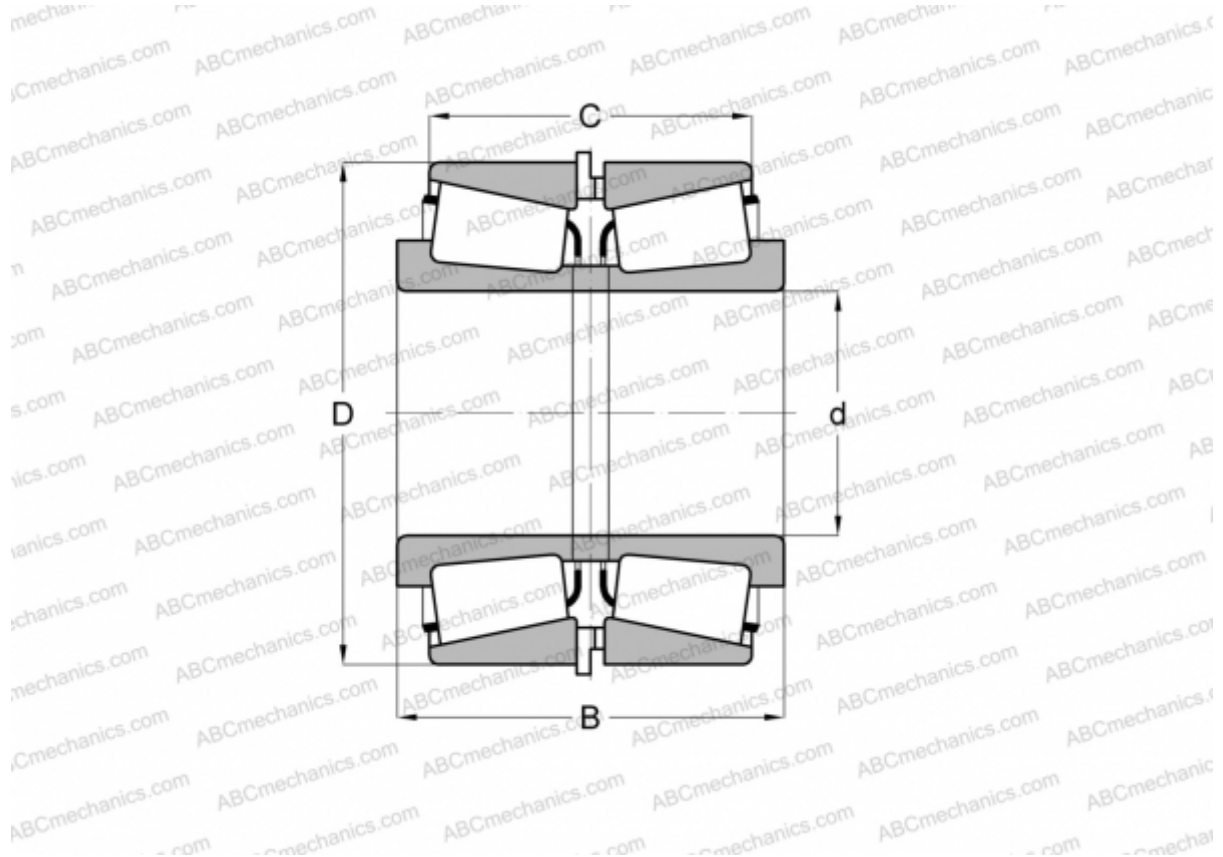

Technical specification

DIMENSIONS, MM

d	90,000
D	145,000
B	78,491
C	62,489

WEIGHT, KG 4,590

MANUFACTURER [TIMKEN](#)