

47896/47820 + X2S-47896/Y3S-47820

TIMKEN

Tapered roller bearings

TYPE: Roller bearings, Tapered, Tapered roller bearing assembly, Type 2TS-IM (X-mounting), two single row bearing with inner and outer distance rings

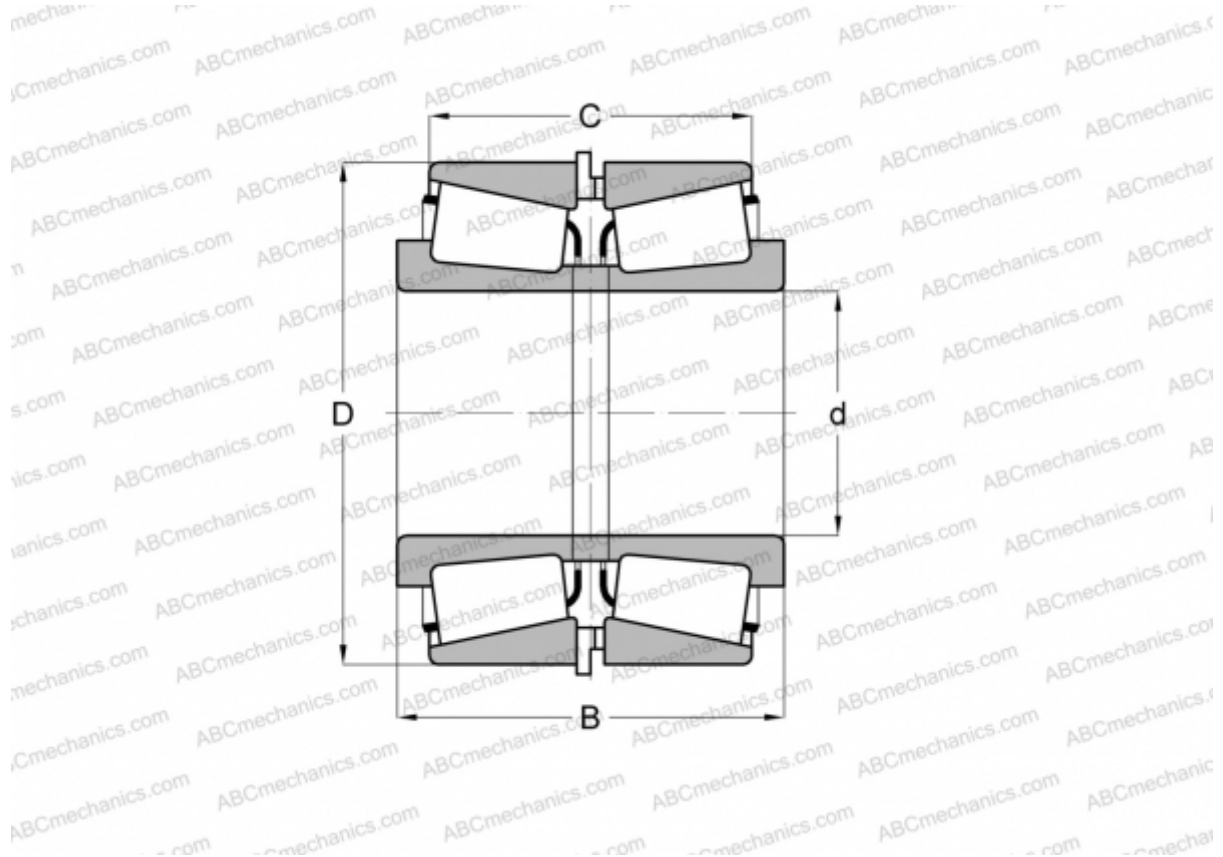

Technical specification

DIMENSIONS, MM

d	95,250
D	146,050
B	80,975
C	66,690

WEIGHT, KG 4,380

MANUFACTURER [TIMKEN](#)