

## 683/672 + X3S-683/Y7S-672 TIMKEN

Tapered roller bearings

TYPE: Roller bearings, Tapered, Tapered roller bearing assembly, Type 2TS-IM (X-mounting), two single row bearing with inner and outer distance rings

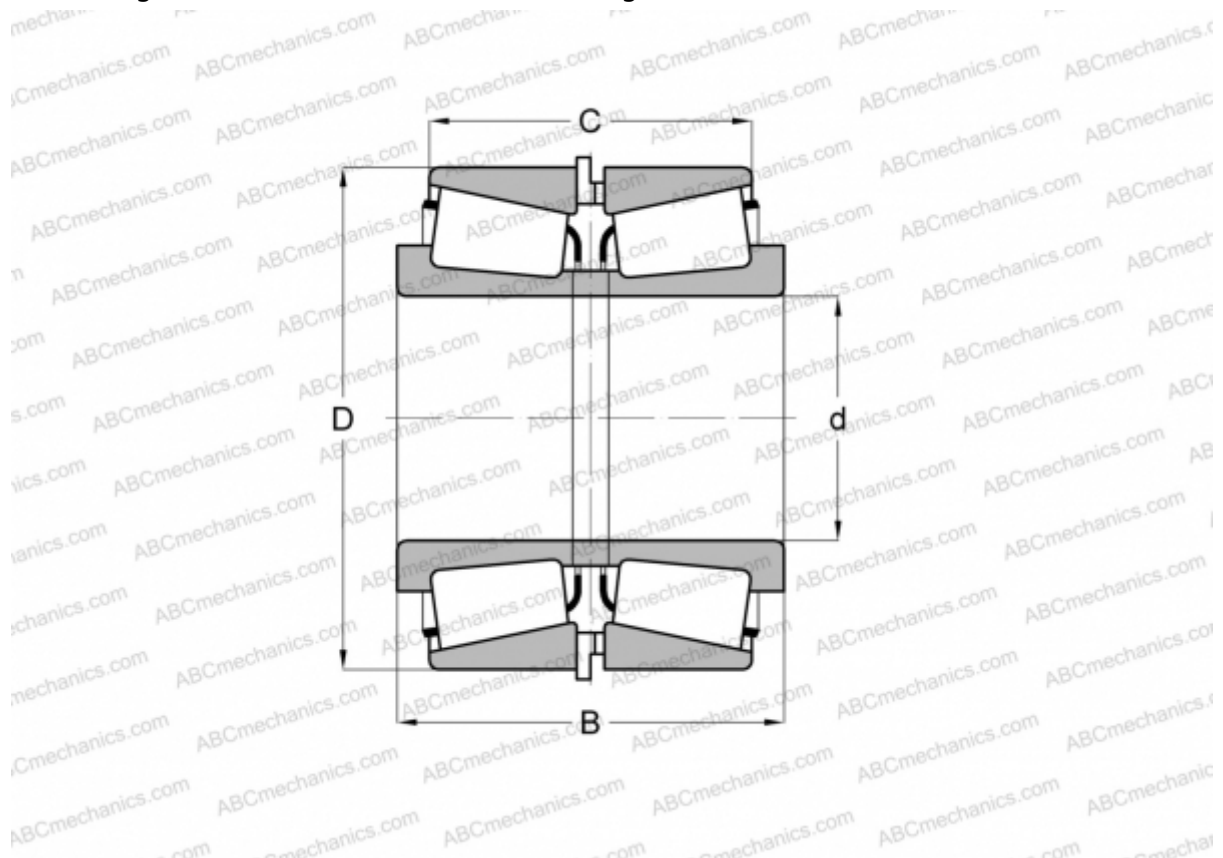

### Technical specification

#### DIMENSIONS, MM

d	95,250
D	168,275
B	212,725
C	190,500

**WEIGHT, KG** 14,100

**MANUFACTURER** [TIMKEN](#)