

37425/37625 + X6S-37425 TIMKEN

Tapered roller bearings

TYPE: Roller bearings, Tapered, Tapered roller bearing assembly, Type 2TS-IM (X-mounting), two single row bearing with inner and outer distance rings

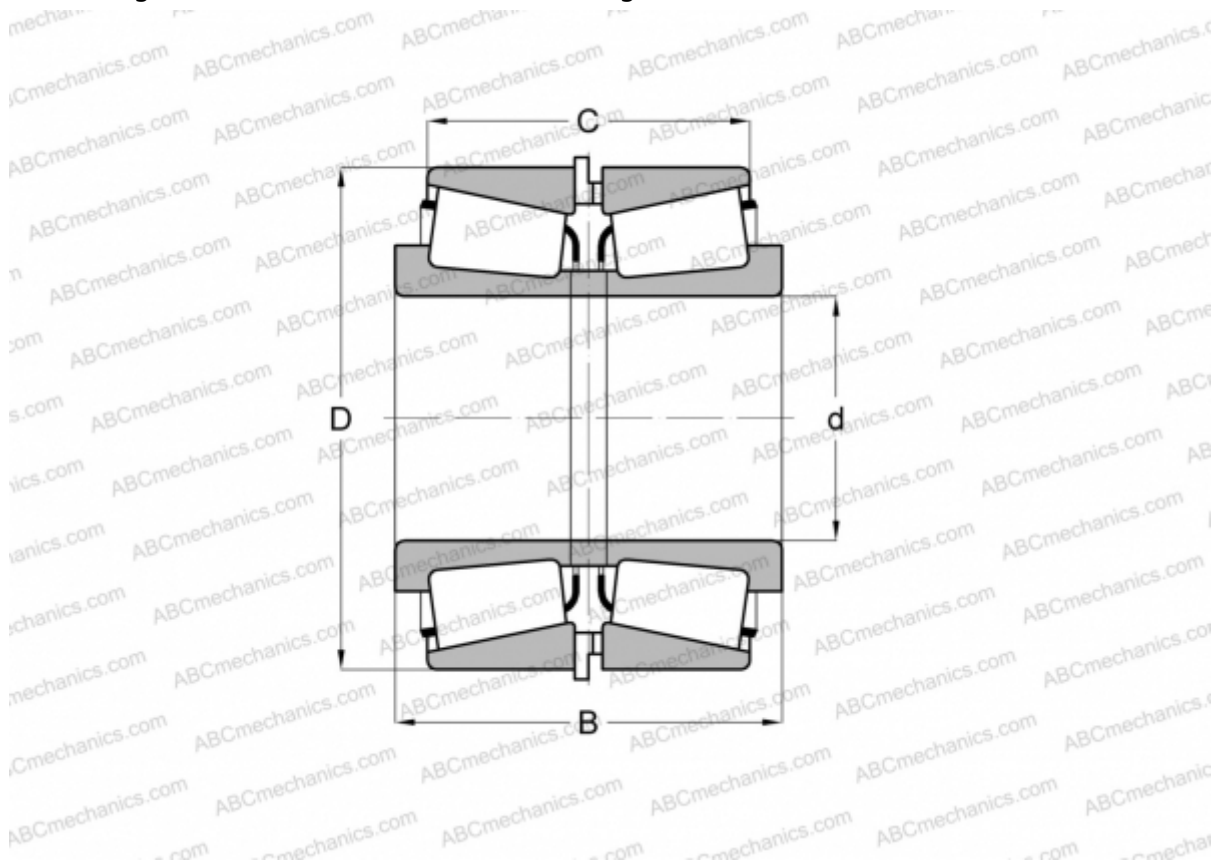

Technical specification

DIMENSIONS, MM

d	107,950
D	158,750
B	50,002
C	35,712

WEIGHT, KG 2,850

MANUFACTURER [TIMKEN](#)