

48190/48120 + X3S-48190 TIMKEN

Tapered roller bearings

TYPE: Roller bearings, Tapered, Tapered roller bearing assembly, Type 2TS-IM (X-mounting), two single row bearing with inner and outer distance rings

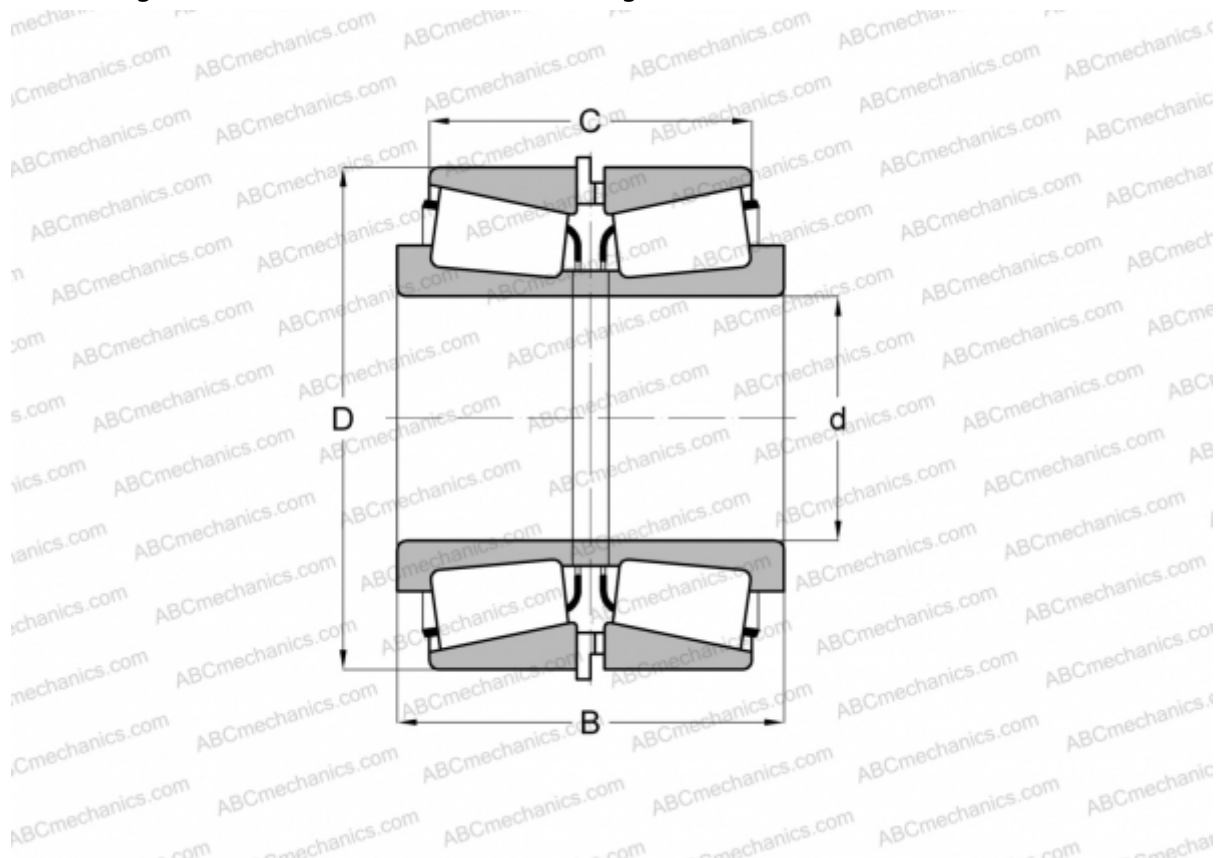

Technical specification

DIMENSIONS, MM

d	107,950
D	161,925
B	82,550
C	66,675

WEIGHT, KG 4,810

MANUFACTURER [TIMKEN](#)