

64450/64700 + X1S-64450/Y8S-64700

TIMKEN

Tapered roller bearings

TYPE: Roller bearings, Tapered, Tapered roller bearing assembly, Type 2TS-IM (X-mounting), two single row bearing with inner and outer distance rings

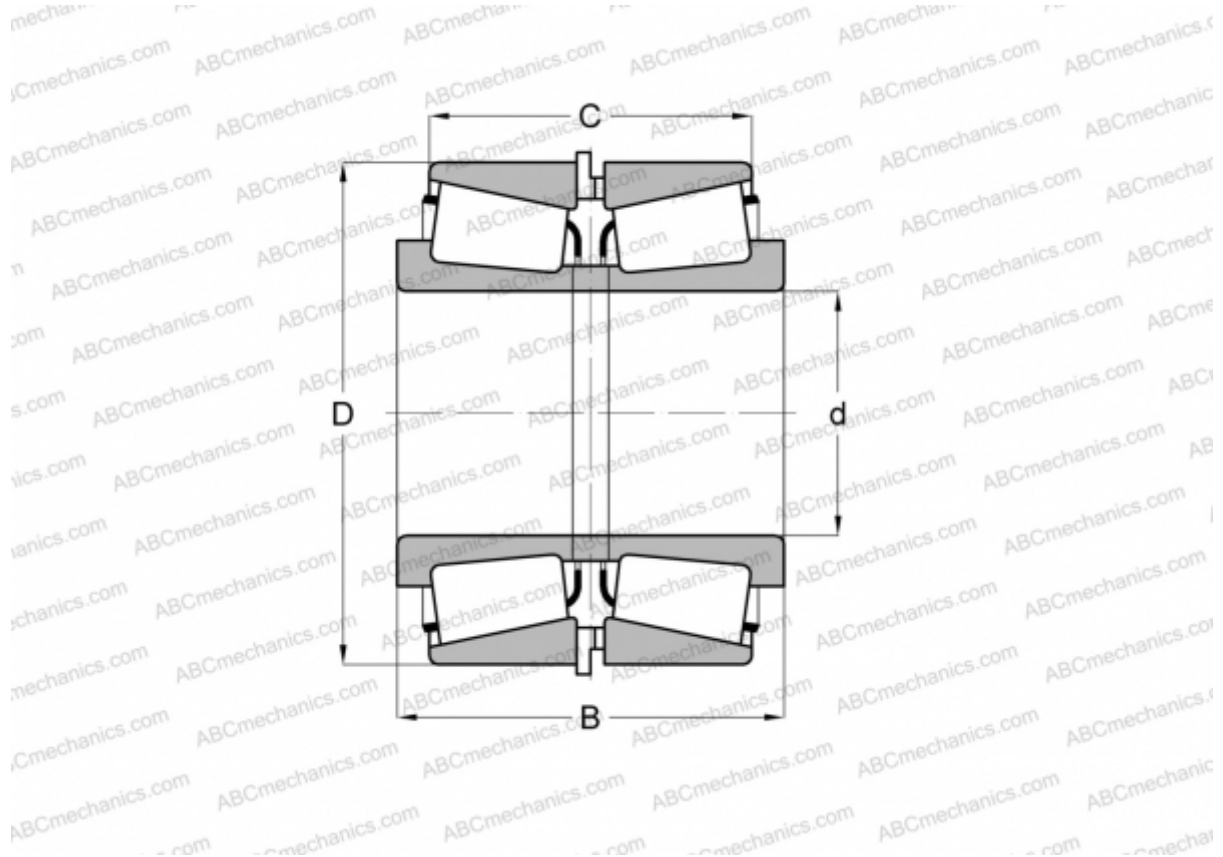

Technical specification

DIMENSIONS, MM

d	114,300
D	177,800
B	92,075
C	69,850

WEIGHT, KG 7,390

MANUFACTURER [TIMKEN](#)