

938/932 + X7S-938/Y10S-932 TIMKEN

Tapered roller bearings

TYPE: Roller bearings, Tapered, Tapered roller bearing assembly, Type 2TS-IM (X-mounting), two single row bearing with inner and outer distance rings

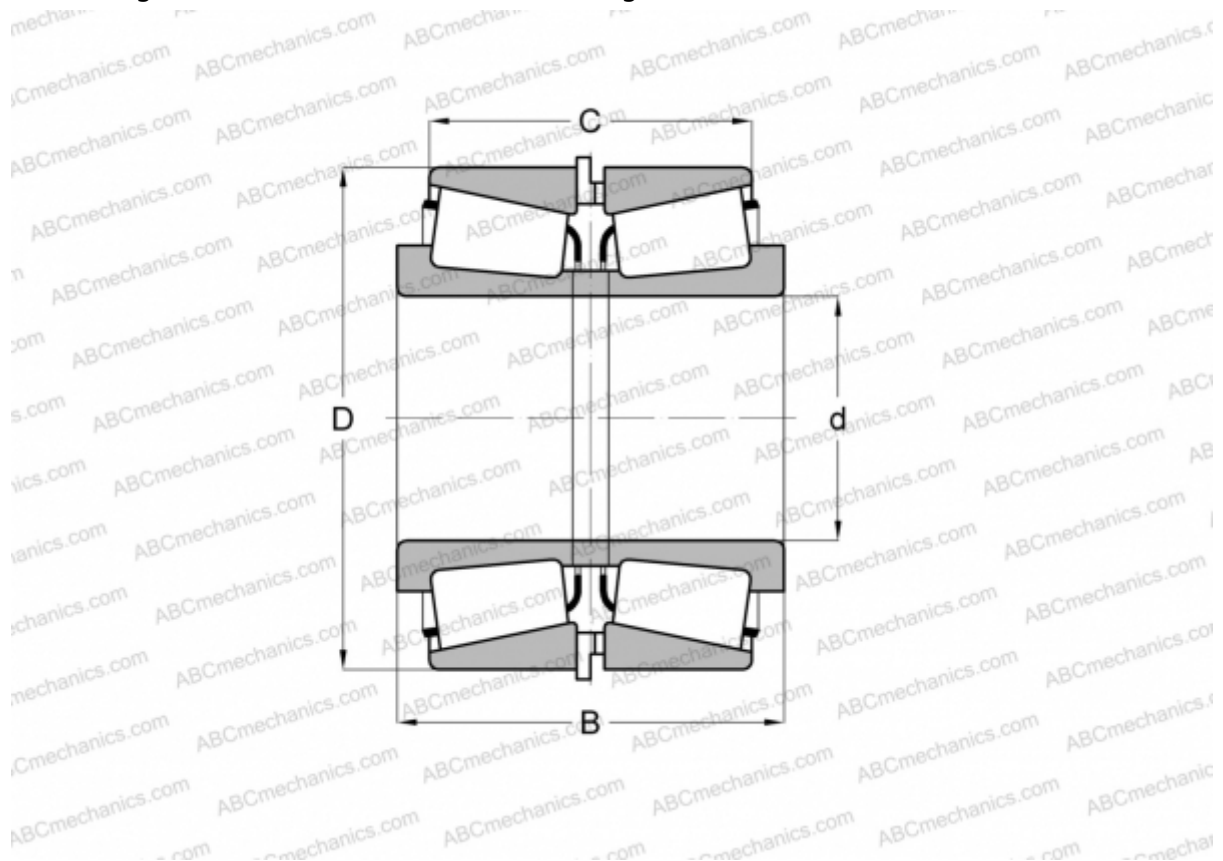

Technical specification

DIMENSIONS, MM

d	114,300
D	212,725
B	152,400
C	127,000

WEIGHT, KG 21,290

MANUFACTURER [TIMKEN](#)