

## 48290/48220 + X1S-48290/Y7S-48220

### TIMKEN

Tapered roller bearings

TYPE: Roller bearings, Tapered, Tapered roller bearing assembly, Type 2TS-IM (X-mounting), two single row bearing with inner and outer distance rings

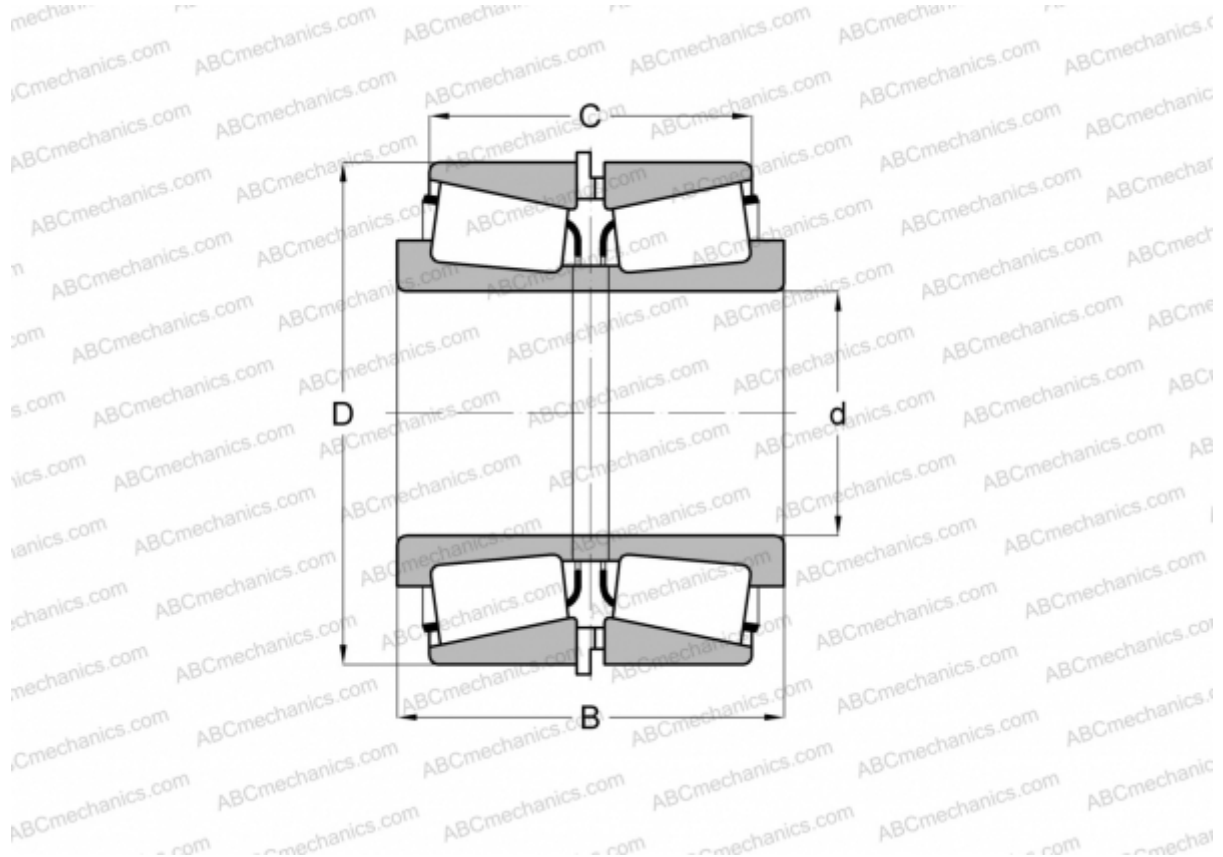

### Technical specification

#### DIMENSIONS, MM

d	127,000
D	182,562
B	85,725
C	73,025

**WEIGHT, KG** 6,890

**MANUFACTURER** [TIMKEN](#)