

95525/95925 + K160046/K160047 TIMKEN

Tapered roller bearings

TYPE: Roller bearings, Tapered, Tapered roller bearing assembly, Type 2TS-IM (X-mounting), two single row bearing with inner and outer distance rings

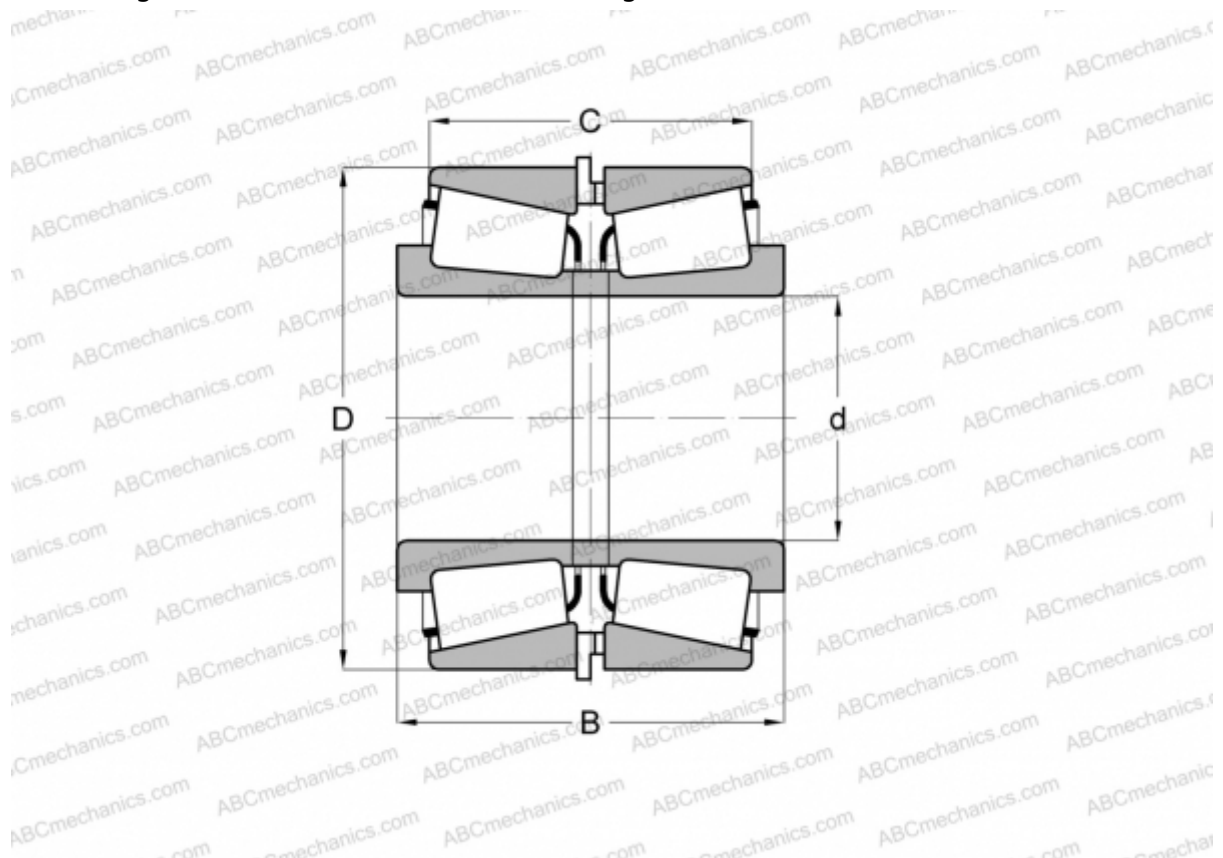

Technical specification

DIMENSIONS, MM

d	133,350
D	234,950
B	138,500
C	109,926

WEIGHT, KG 23,240

MANUFACTURER [TIMKEN](#)