

48393/48320 + X6S-48393 TIMKEN

Tapered roller bearings

TYPE: Roller bearings, Tapered, Tapered roller bearing assembly, Type 2TS-IM (X-mounting), two single row bearing with inner and outer distance rings

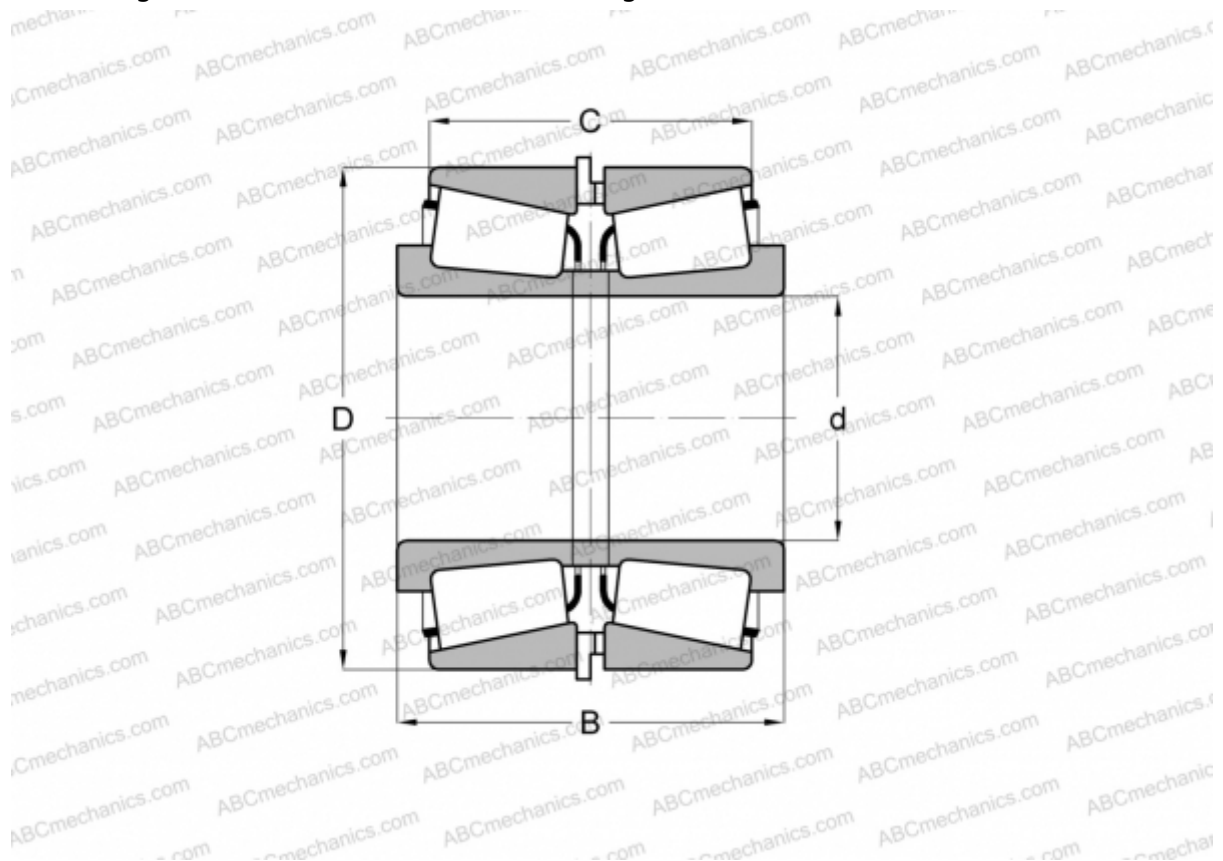

Technical specification

DIMENSIONS, MM

d	136,525
D	190,500
B	88,694
C	75,994

WEIGHT, KG 6,930

MANUFACTURER [TIMKEN](#)